

Termik

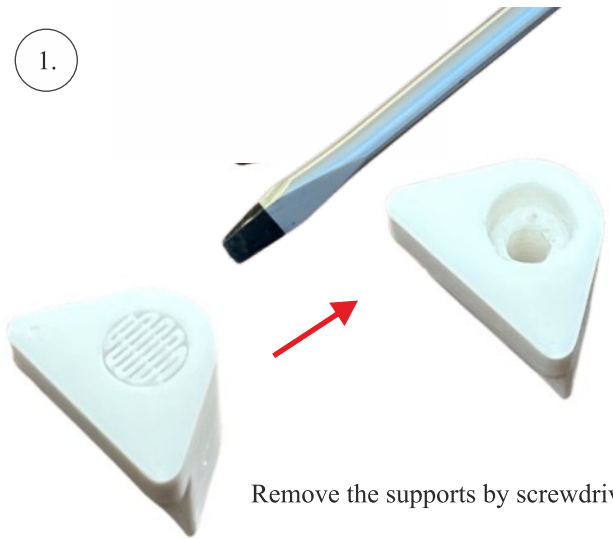

1.



Remove the supports by screwdriver

2.

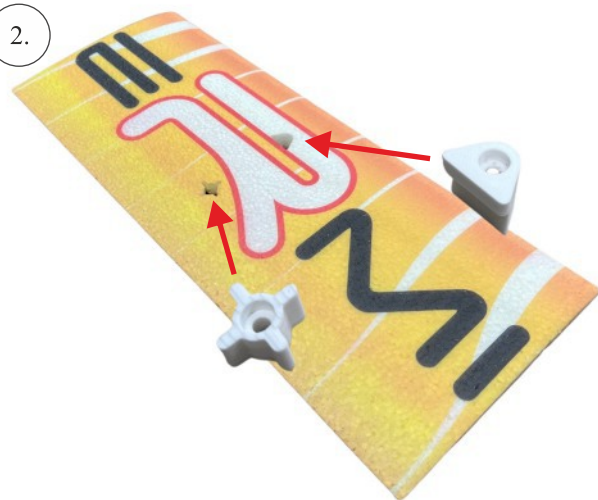

3.

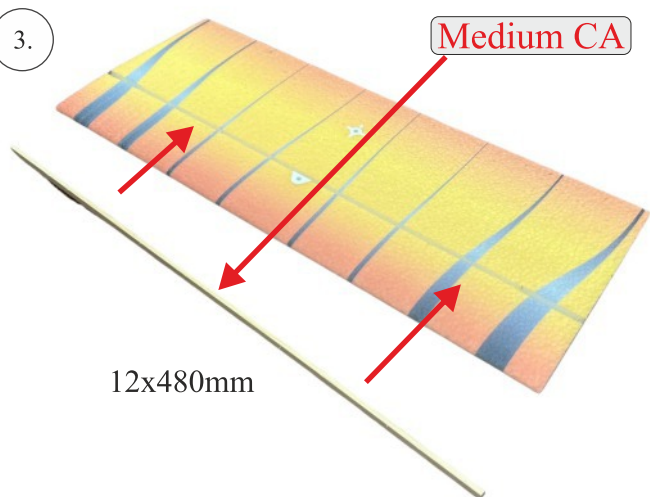

12x480mm

Medium CA

4.

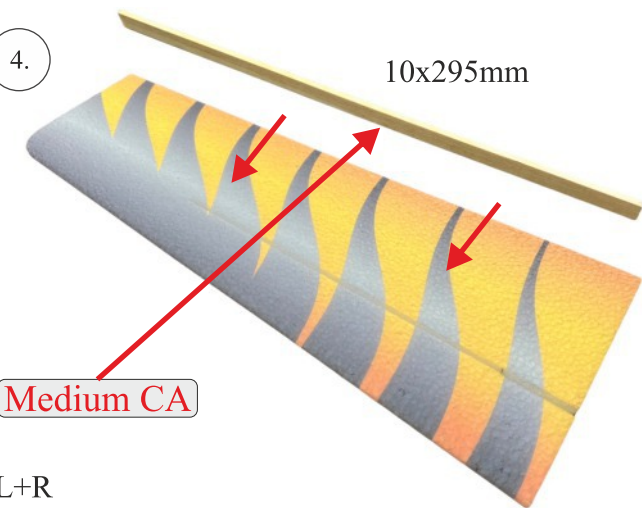

10x295mm

Medium CA

L+R

5.

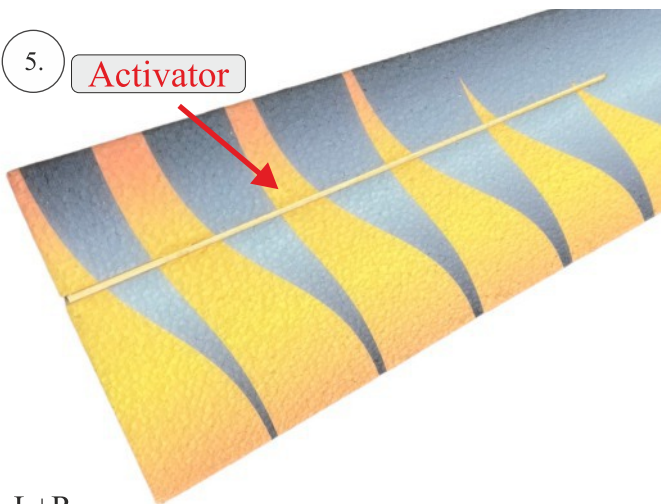

Activator

L+R

6.



prepared for the foil covering

7.

use covering film 38 mic with iron on 145°C



8.



9.

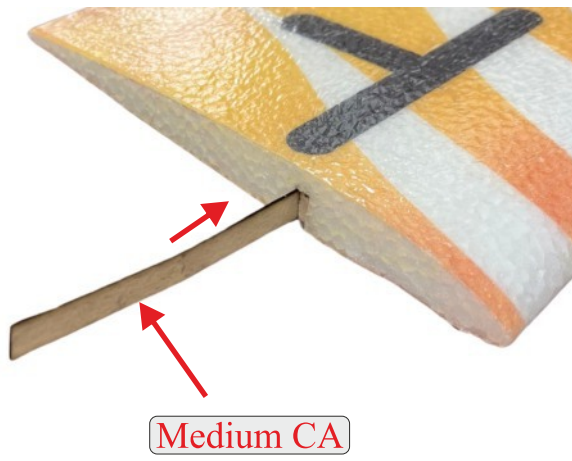

10.

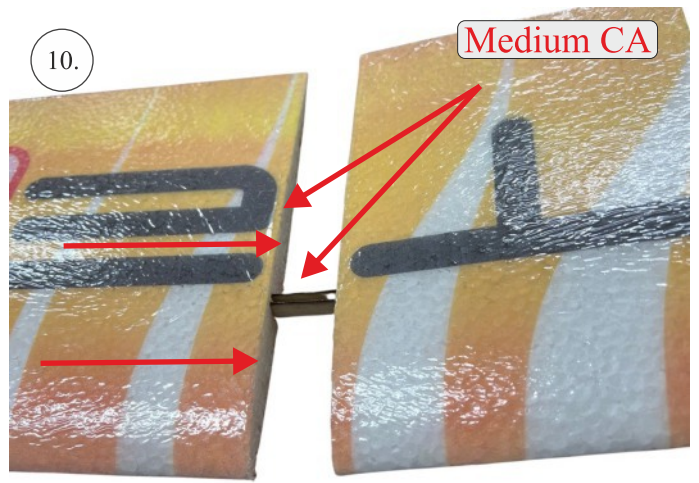

11.



12.

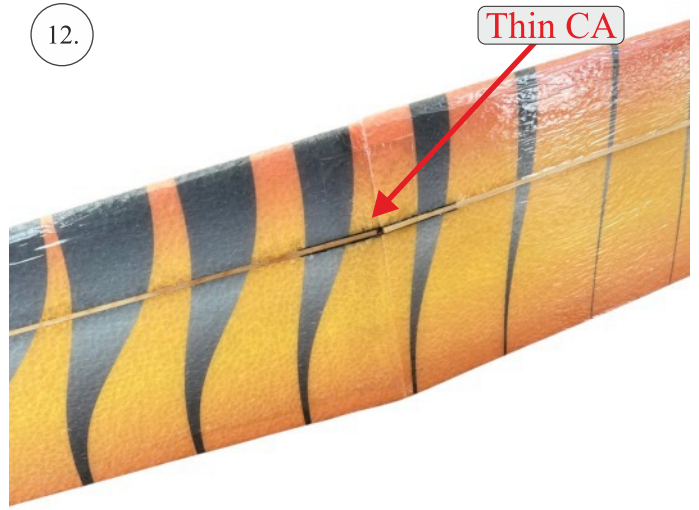

13.

you can cover the join by foil



14.

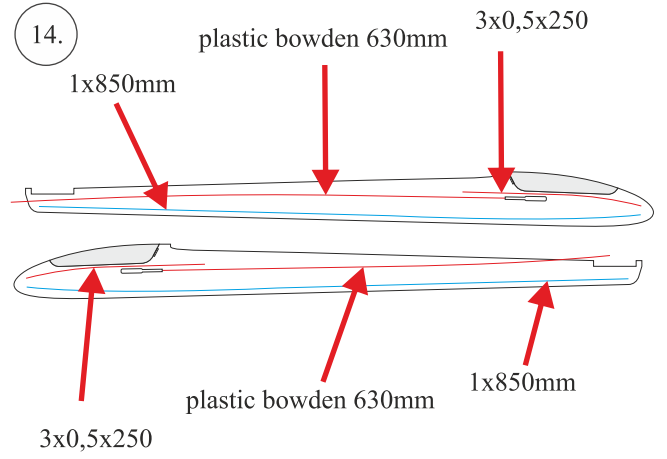

15.

L+R

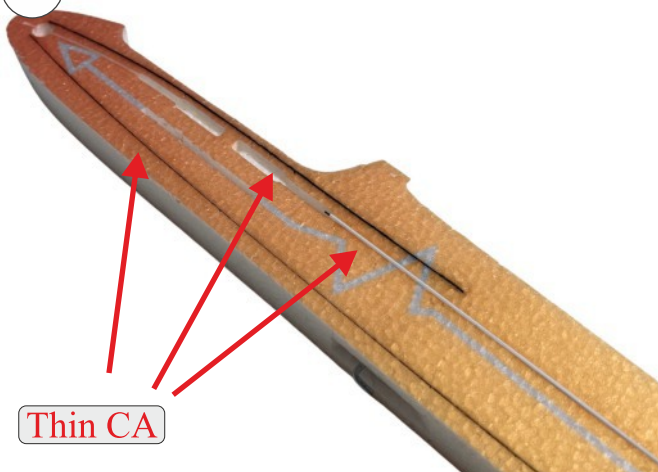

16.

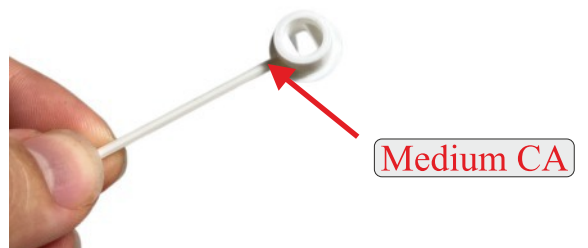
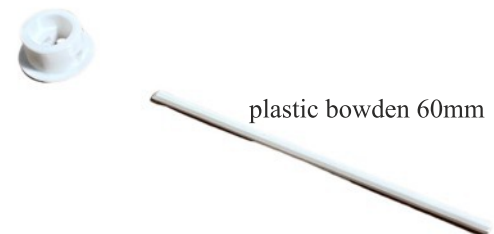

17.

Thin CA

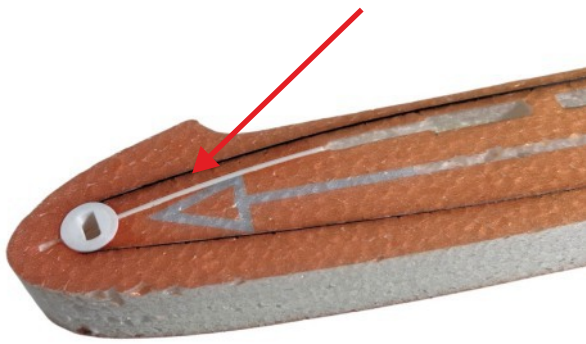

18.

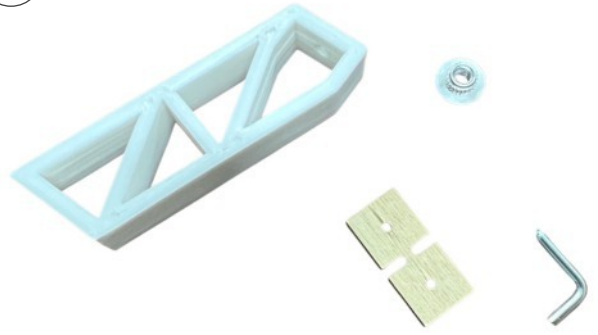

19.

Medium CA



20.

Medium CA

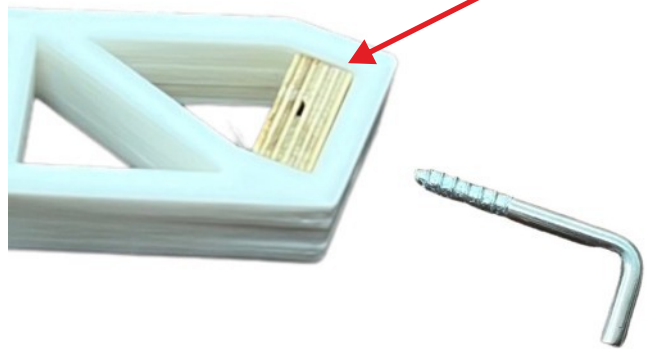

21.

use pliers for the 4mm nut



Medium CA

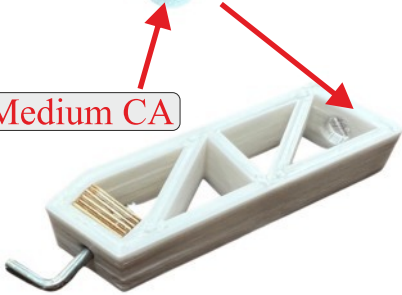

22.



23.

Medium CA

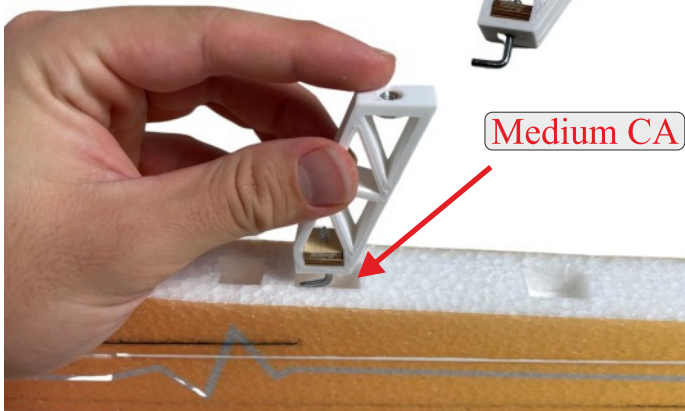

24.

be careful whether it is in the same line



25.

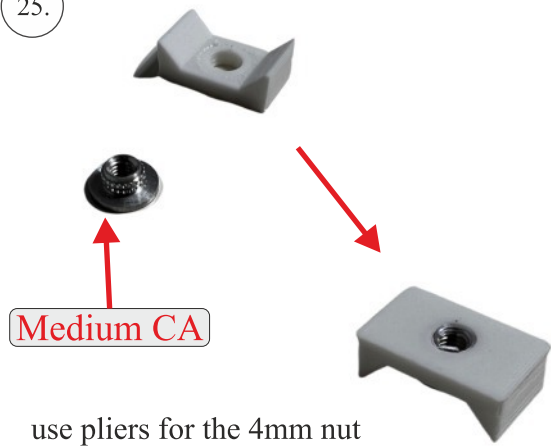

Medium CA

use pliers for the 4mm nut

26.

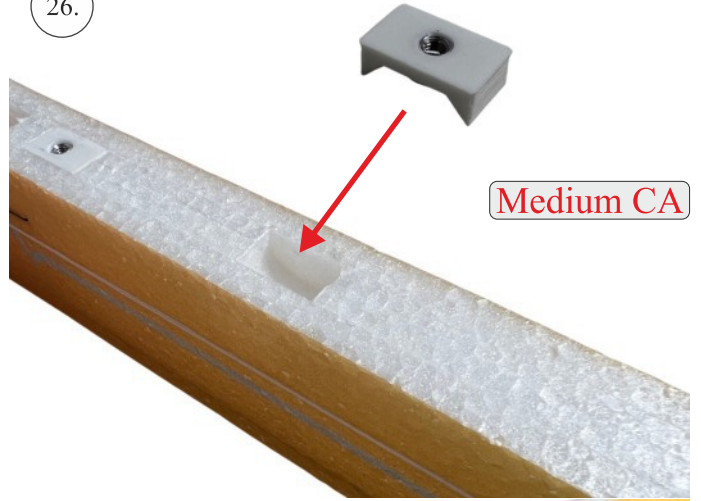

Medium CA

27.

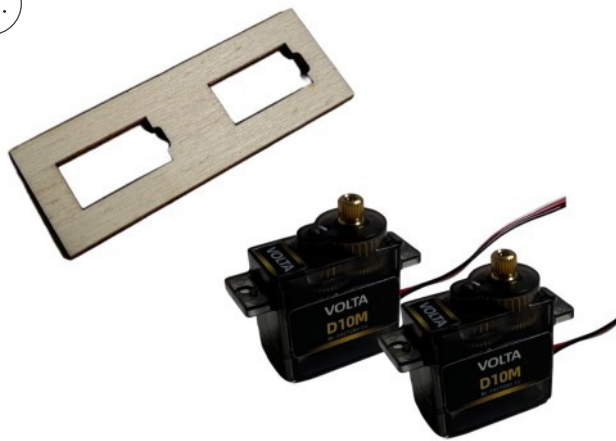

put the servos in the fuselage

2nd
1st

28.

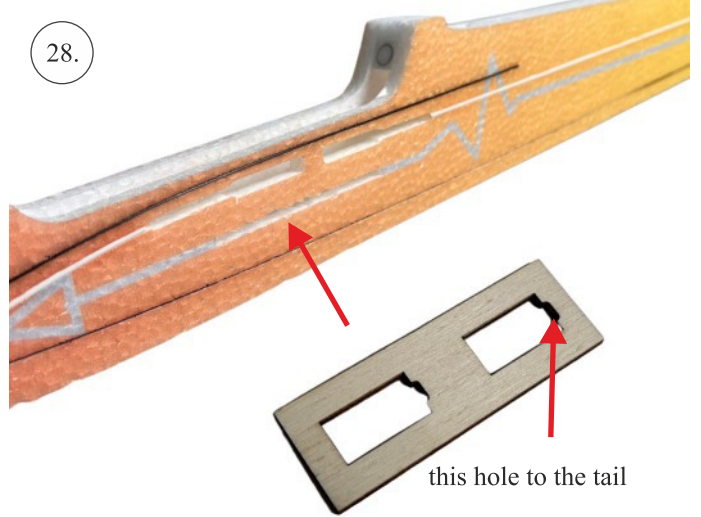

this hole to the tail

29.

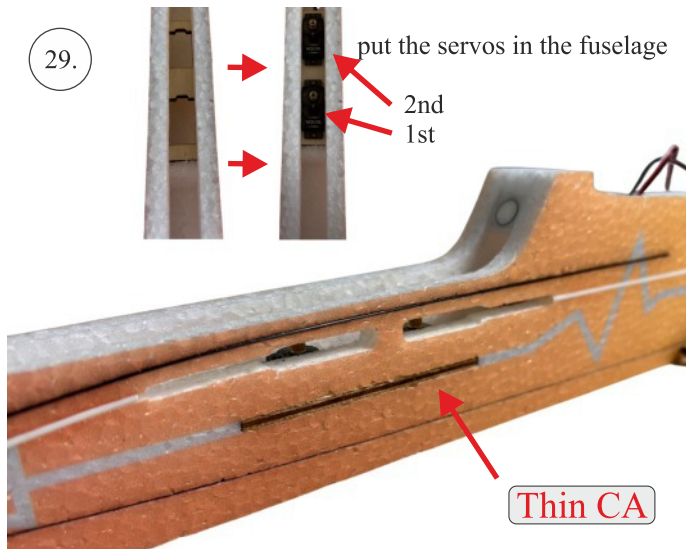

Thin CA

30.



all parts are ready for foil ironing

31.

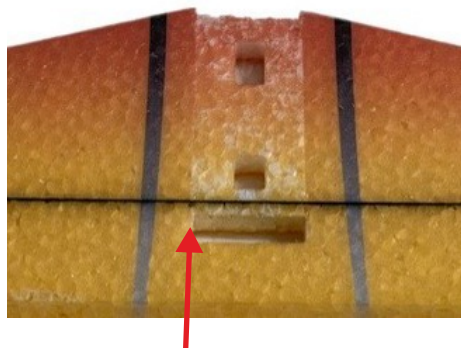

do not leave the places that will be glued covered with foil

32.

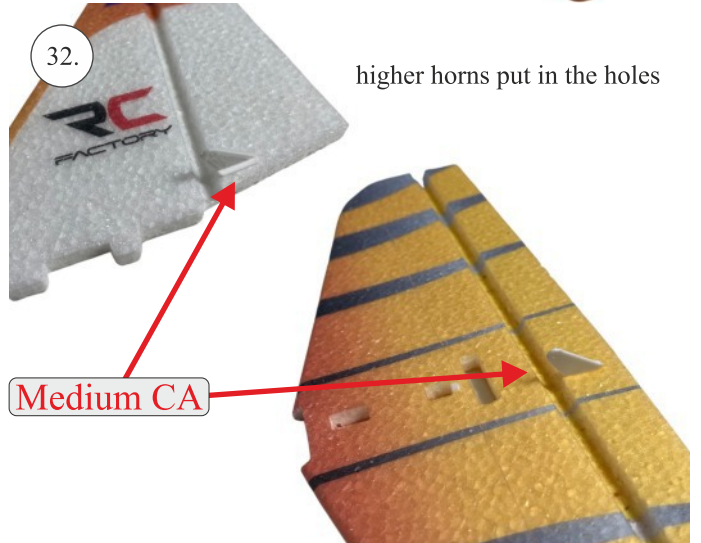

higher horns put in the holes

Medium CA

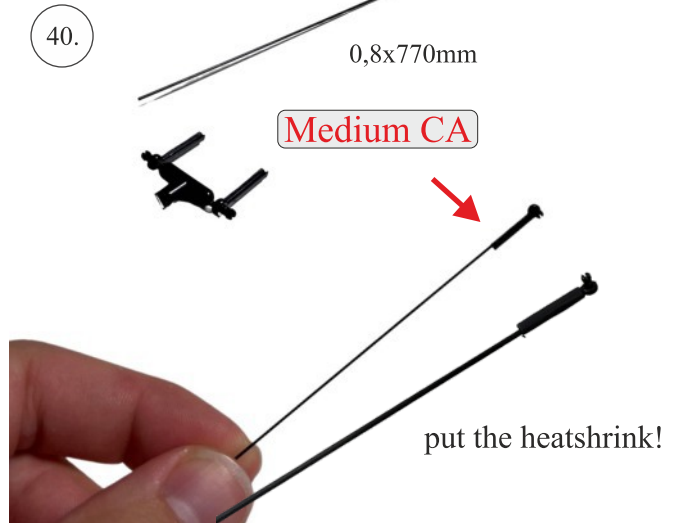
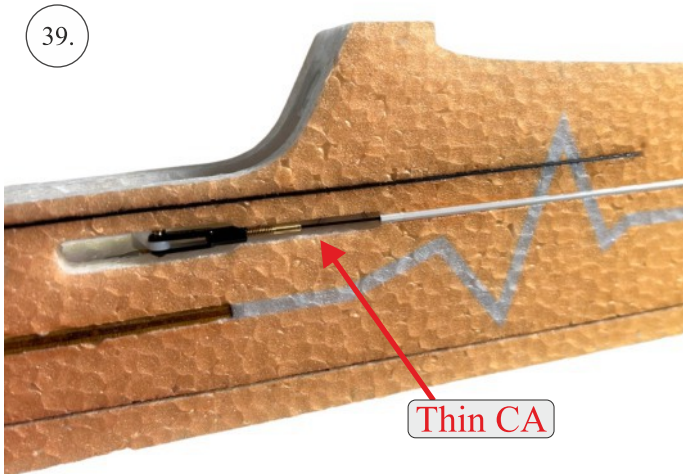
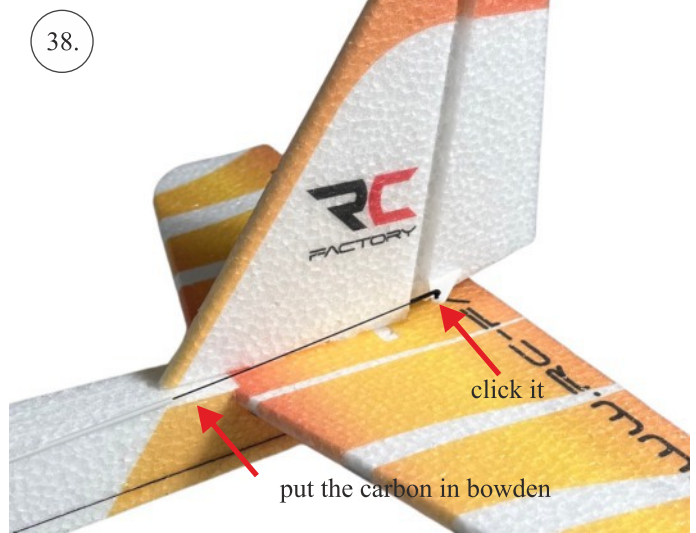
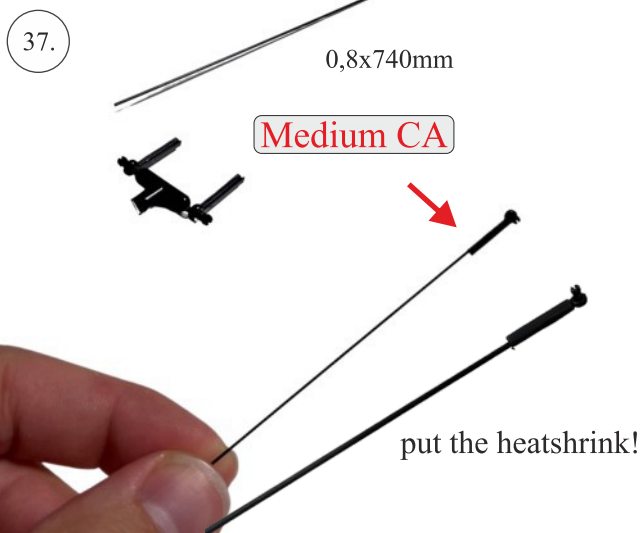
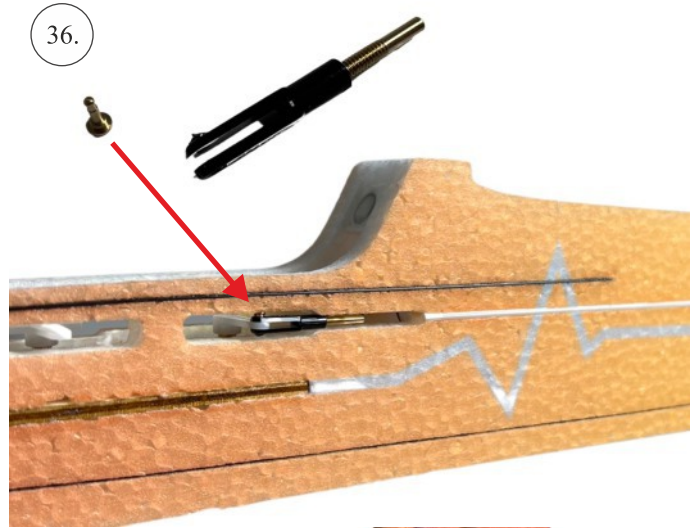
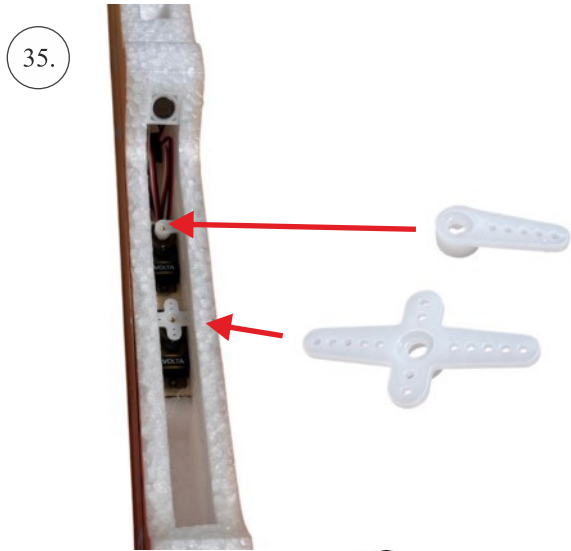
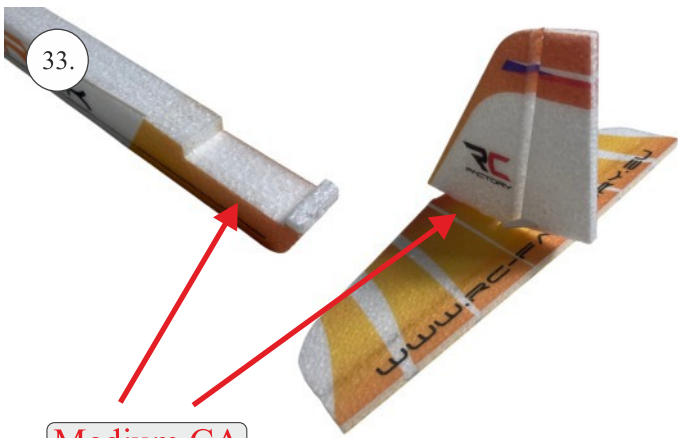

41.

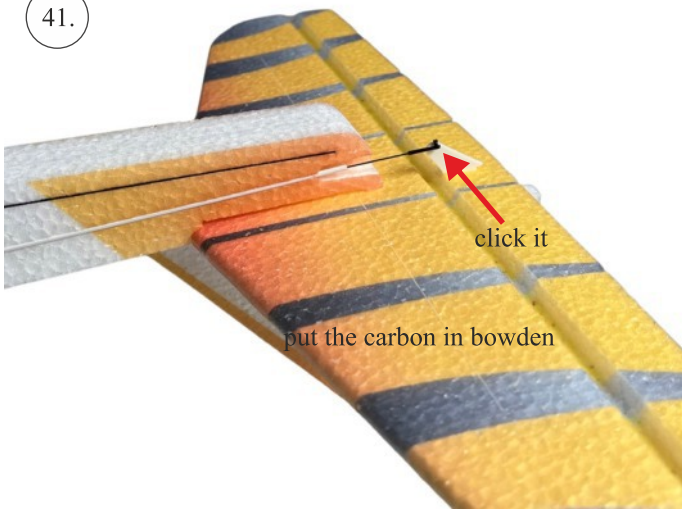

42.

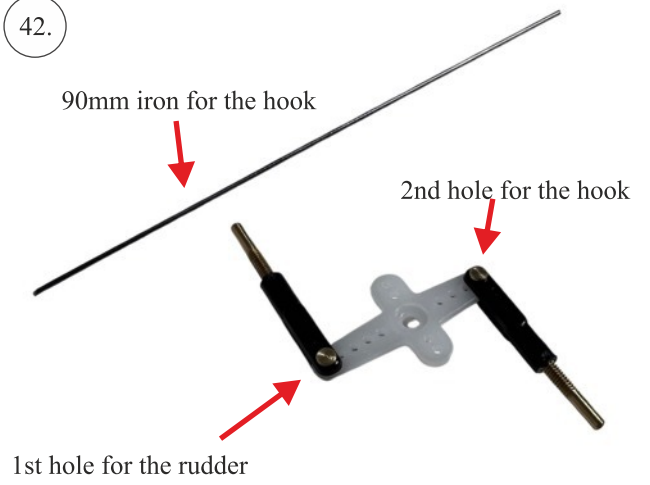

43.

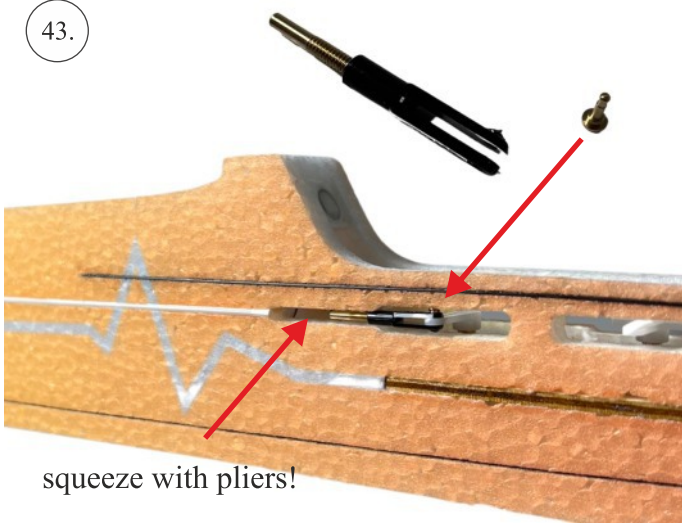

44.

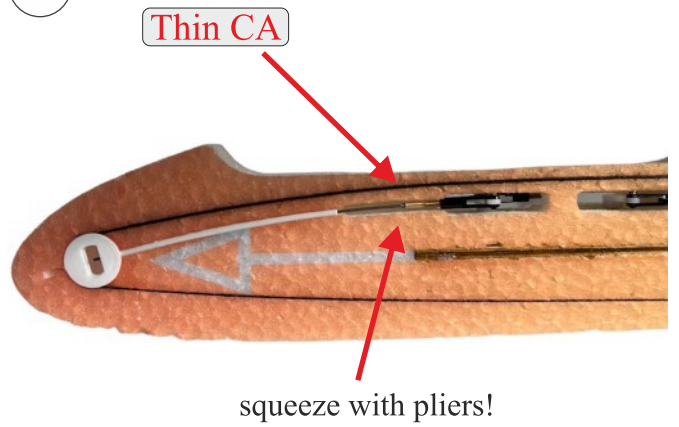

45.



46.



47.

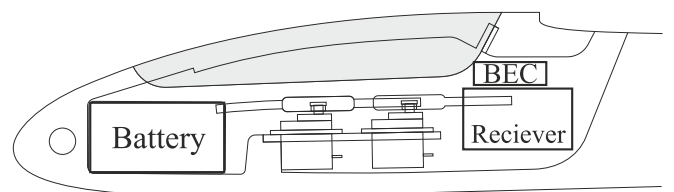
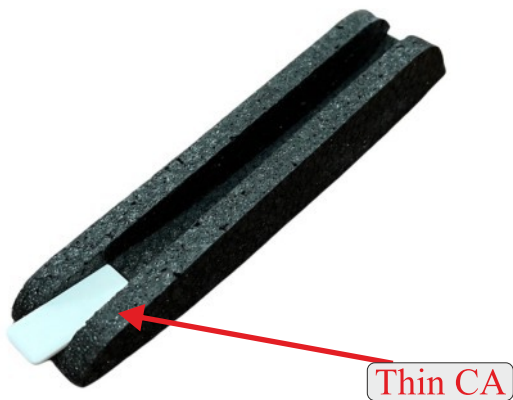

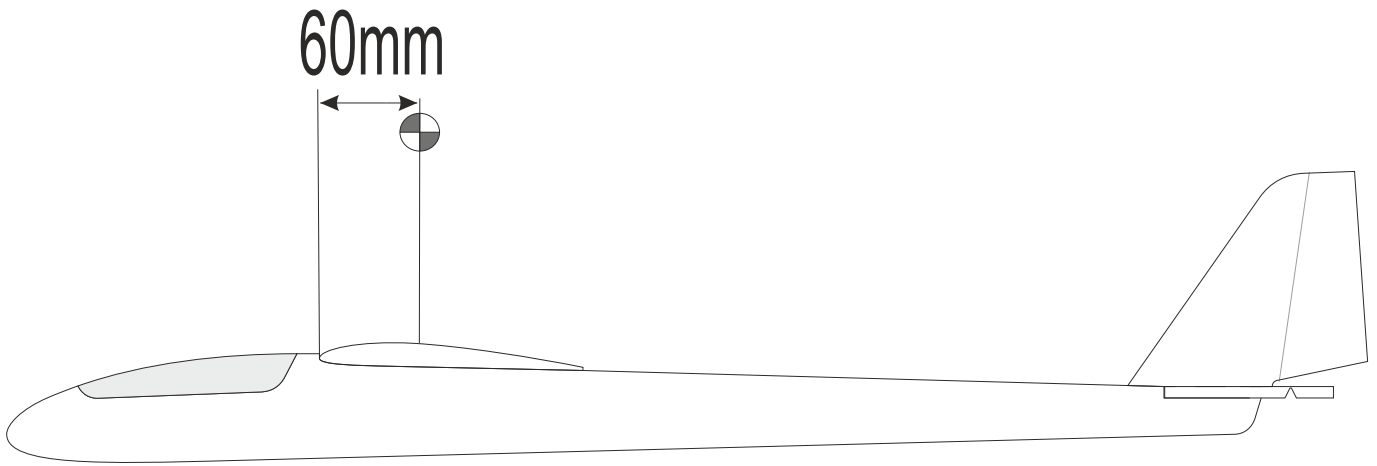

We wish you many happy flying hours with the Termik.

Your RC Factory team