

E SKY®

HONEY BEE CP3 002437

3D Aerobatic Training Helicopter



规格参数

- 全长: 525mm
- 全高: 185mm
- 主旋翼直径: Φ 540mm
- 尾旋翼直径: Φ 80mm
- 马达齿轮: 8T
- 整机重: 约370g

标准配备

- 11.1V 1000mAh 锂电池
- 370强磁马达+CN12马达
- 7.5g数字伺服器 (扭力:1.0kg·cm,速度:0.1s/60°)
- 2.4GHz 六通道发射机
- 2.4GHz 六通道接收机
- 三合一控制器 (包含: 陀螺仪、电子调速器、混控)

Specification

- Length:525mm
- Height:185mm
- Main blade diameter: Φ 540mm
- Tail blade diameter: Φ 80mm
- Motor gear:8T
- Weight:about 370g

Standard Equipments

- 11.1V 1000mAh Li-polymer battery
- Super370 motor+CN12 motor
- Digital servos(7.5g,1.0kg·cm,0.1s/60°)
- 6-channel 2.4GHz Transmitter
- 6-channel 2.4GHz Receiver
- "3 in 1" controller(W/gyro,mixer,ESC)

※本机在尚未进行重大改版之前, 配件可能进行调整, 外观、型号可能稍有不同。E-SKY保留配件内容更改权, 并不另行通知。
ESKY reserves the right to change or modify the appearance and specification of the unit and the parts without prior notice.

目录 Contents

一	前言 Brief introduction	1
二	重要声明 Statement	1
三	安全注意事项 Safety notes	2
四	检查包装物及配件 Packaging Contents	3
五	锂电池充电 Charging the Li-Po Battery	4
六	发射机介绍 Introduction of Transmitter	5
七	飞行前舵面的检查 Controls Test	11
八	直升机部件介绍 Helicopter Parts	12
九	重新对码的方法 How to Re-bind	13
十	三合一控制器的调整 “3 in 1” Mix Controller Adjustment	14
十一	主旋翼双桨的调整 Blade tracking adjustment	17
十二	飞行操作步骤 Procedure for flight	18
十三	分解图 Exploded view	19
十四	配件图 Spare parts list	21

一、前言 Brief introduction

感谢您选择ESKY的产品! 这款“Honey Bee CP3”直升机是专为3D初学者开发的一款标准六通道电动直升机。

为了让您更好的了解和这款遥控直升机, 请您务必仔细地阅读本产品说明书, 然后再进行组装及操作。以确保您正确使用及安全操作!

请妥善保存本说明书, 以协助您顺利的进行直升机的调整、维修等作业。

Thank you for purchasing ESKY product. HONEYBEE CP3 is a standard 6-channel electric helicopter. It is a professional training model designed for RC beginners who demand rapid improvement in flying skills. Its design offers the most superior stability. The durable material ensures capability of withstanding most crashes while the simple structure makes it easy for maintenance.

To ensure safety, you are recommended to read the instruction manual thoroughly before any assembly and operation. Please keep the manual properly for future maintenance.

二、重要声明 Statement

遥控模型不是玩具!!

旋转中的旋翼、马达、齿轮等部件具有一定的危险性, 若操作不慎或者使用不当都有可能造成伤害。

本产品出厂时已经组装、调试完成。除非您具有一定的遥控直升机操作、调整经验, 否则请勿任意拆卸直升机上的零件。本公司无法针对操作失误或者组装不当所造成的意外负任何责任。

模型产品包含部分消耗零件。反复的拆装、长时间的飞行、操作失误等都会造成部分零件的损坏, 这属于正常损耗范围。请定期检测并更换损耗配件以确保飞行安全。如出现上述损耗, 导致产品故障或损坏, 本公司将不会进行退货或更换新品。

R/C helicopters, including the ESKY Helicopter are not toys. R/C helicopters utilize various high-tech products and technologies to provide superior performance. The rotating blades on the model spin at high speed can cause potential risk or injury if used improperly. It is mandatory that you observe all R/C safety rules and adhere to local laws as applicable. We recommend that you contact your local hobby store and inquire about safety rules, regulations and local laws and statutes regarding R/C model operation in your area. Please make sure to be conscious of your own personal safety and the safety of others and your environment when operating all ESKY products. If used properly, ESKY R/C products will provide years of R/C entertainment.

We recommend that you obtain the assistance of an experienced pilot before attempting to fly our products for the first time. A local expert can assist you to properly assemble, set up, and fly your model for the first time.

The HONEYBEE CP3 requires a certain degree of skill to operate, and is a consumer item. Any damage or dissatisfaction as a result of accidents or modifications are not covered by any warranty and can not be returned for repair or replacement. Please contact our distributors for free technical consultation and parts are at discounted rates when you experience problems during operation or maintenance.

It is not the policy or practice of ESKY HOBBY to exchange or return parts after the package has been opened. In case you discover any parts that might be defective or missing, please contact the retailer who sold you the product. Get their signature on your Customer's Card and contact ESKY HOBBY with a description of the problem parts.

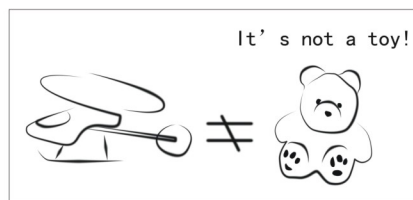

三、安全注意事项 Safety Precautions



警告 Warning

此符号表示：若疏忽警告说明，将可能会给自身或他人造成危害！需要特别留意！
Accidents may arise from carelessness of these signs.

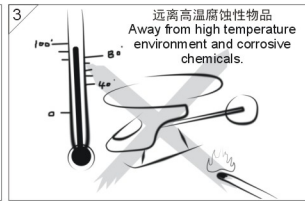
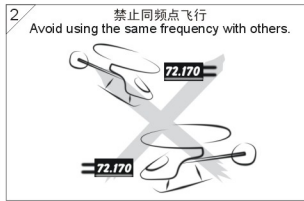
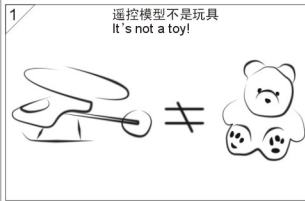

- 1、遥控模型不是玩具！具有一定的危险性，禁止14岁以下人士进行操作！
Incorrect operation may cause serious injury or damage! Not suitable for the player under 14 years. The helicopter should not be operated by Children.
- 2、飞行前需要检测飞行场地周围是否有相同频率的遥控设备在使用！须避免与他人同时使用相同频率的遥控设备！
Before starting your flight, always make sure that there is NOT remote control equipments on the same frequency (channel) used in the same flying area. The radio signal interference may cause a crash.
- 3、直升机在存放与飞行时，需要远离高温环境或是其他具有腐蚀性的化学物品！
Keep it away from high temperature environment and corrosive chemicals for storage and flight.
- 4、初学者请勿独自操控！初次飞行时最好请有经验的飞行员进行指导之后再行飞行。
If you are not an experienced pilot or have not flown this type of model before, we recommend that you get the assistance of an experienced pilot for your first flights.
- 5、初学者须由基本飞行练习开始！
Beginners are suggested to start with more flying practice on simulator or flying set.



禁止 Prohibition

此符号表示：在任何情况下，绝对禁止的行为！
These acts are strictly prohibited under any circumstances to prevent accidents.

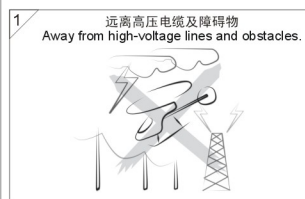

- 1、飞行时应该远离高压电线或其他影响飞行的建筑物！
Keep away from high tension power lines, high buildings or any other obstacles while flying.
- 2、飞行时要远离人群，避免旁人围观！以免误伤他人！
Keep away from crowds in case of accidental injury.
- 3、请勿在下雨、打雷、阴天或是视线不清楚的天气进行飞行！
Do NOT operate in rain, thunder, storms, lightning, strong wind or other bad weather.
- 4、直升机在飞行运转时禁止用手或是其他物品触及直升机！以避免不必要的损失和危险状况发生。
Keep people and objects away from the spinning unit and parts in case of accidental injury or damage.

四、检查包装物及配件 Packaging Contents

打开包装盒后，请先检查附送配件是否齐全完整。若有遗漏，请向所购买的单位反映、索取。

Please check the parts and accessories in the package. In case you discover any parts or accessories defective or missing, please contact the retailer for help.

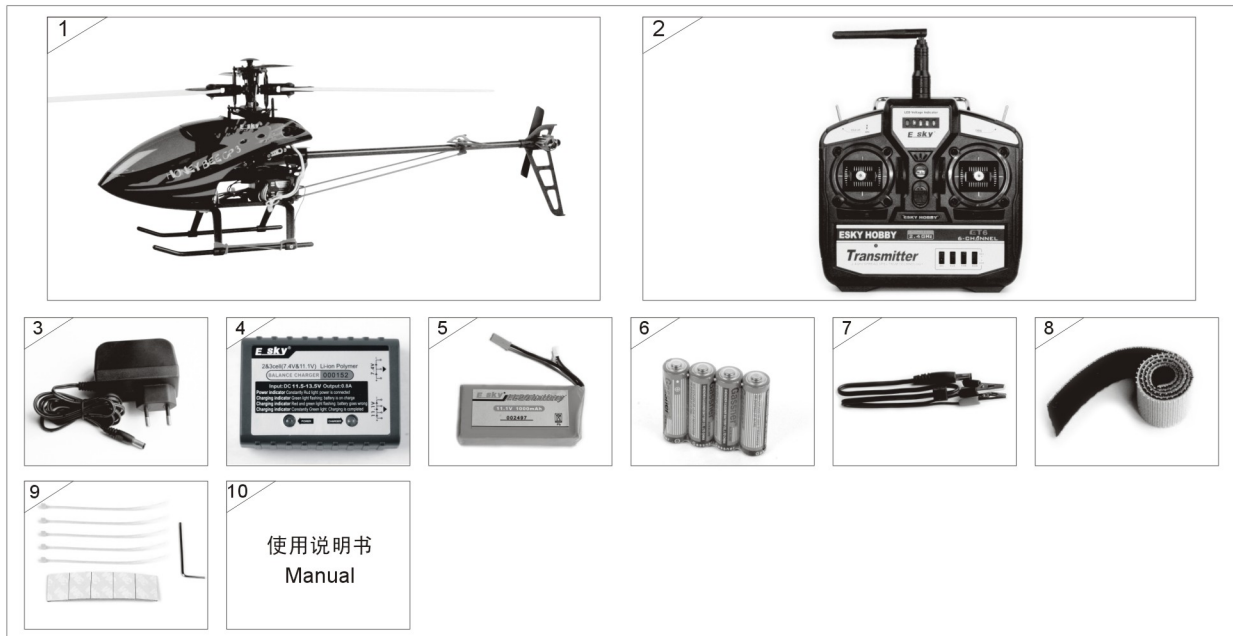

1. 直升机.....	1	Honey bee cp3	1
2. 6通道发射机	1	6 channel transmitter.....	1
3. 电源适配器.....	1	Switching adapter.....	1
4. 平衡充电器	1	Balancer charger for 2-3 cells li-poly battery.....	1
5. 11. 1V 1000mAh 锂聚合物电池组	1	1000mAh, 11.1V, Li-poly battery	1
6. 1. 5V “AA” 干电池.....	4	1.5V “AA” Battery	4
7. DC12V 电源线	1	DC12V crocodile clip of storage battery	1
8. 绑带.....	1	Double Faced Adhesive Tape	1
9. 简易工具包.....	1	Mounting Accessories, Screwdriver & WrenchSet.....	1
10. 使用说明书.....	1	Manual.....	1

HONEY BEE CP3 包装图
HONEY BEE CP3 packing



五、锂电池的充电 Charging the Li-Po Battery

1. 充电器的介绍 About the Charger

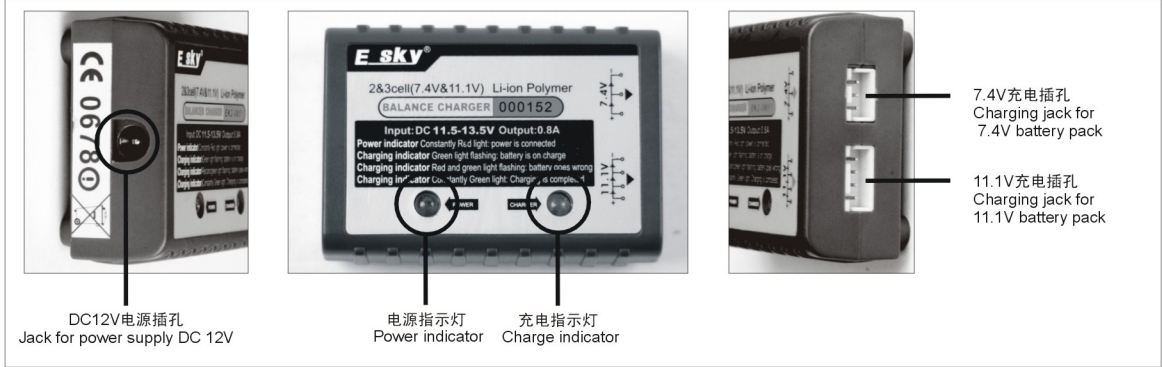

2. 充电电源的选择 Selection of Power Supply



3. 充电步骤 How to Charge

- ①将充电器与12V直流电源连接，Power指示灯会亮起红灯，表示电源连接正常。
Connect the charger with the power supply DC12V. It indicates proper connection if the red POWER light turns on.
- ②将电池充电插头插入侧面对应的充电插孔，绿色Charger灯会开始闪烁，表示开始充电。
Connect the battery to the balance charger. The battery is on charge when the green Charge indicator flashes.
- ③当电池充电完成后，绿色Charger灯会停止闪烁。指示灯转为恒亮，表示电池已经充满。
If the green Charge indicator stops flashing and turns steady, it indicates the battery is fully charged. Remove the battery from the charger and then disconnect the charger from the power supply.

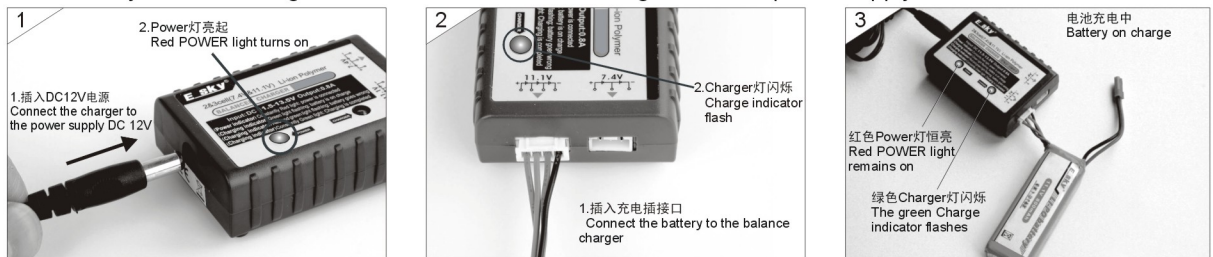

4. 充电注意事项 Charging precautions

- ①充电器接通DC12V电源后，红色的Power电源指示灯如果没有亮起，表示连接有误，或者12V电源有问题。请重新连接，直到正常为止。
If the red POWER light does not turn steady when the charger connected with the DC 12V power supply, it indicates improper connection exists or the power supply does not work well. Please check and reconnect until it works properly.
- ②当电池连接充电器后，如果红色Power灯与绿色Charger指示灯同时闪烁，表示电池有问题，请检查电池是否损坏。
If the red POWER light and the green Charge indicator flash at the same time when the battery connected with the charger, it indicates the battery may be defective. Please check the battery and ensure it is in good condition.

③接上电池后，如果绿色的Charger指示灯不亮，但红色的Power指示灯在闪烁，表示充电器进入保护状态，请拔除DC12V电源约3~5秒后重新连接。

If the red POWER light flashes while the green CHARGER light is not on when the battery connected with the power supply, it indicates the battery is in state of Protection. Please disconnect the DC 12V power supply and reconnect it 3-5 seconds later.

④充电完成后，绿色的Charger指示灯会恒亮，此时请及时取下电池。如果不拔除电池，电池本身的特性会导致自动放电，当电池放电到单节电池电压低于4.15V时，充电器会自动重新给电池充电，直到再一次充满。此过程会反复的进行。

The green Charge indicator will turn steady once the battery is fully charged. Please take off the battery from charger. It will discharge automatically if not disconnected in time and re-charge as the single cell voltage is less than 4.15V until fully charged. The process repeats if not disconnected.

⑤请将电池从直升机上取下后再进行充电，请勿直接在直升机上充电！

Please take off the battery from the helicopter before charging. NEVER charge the battery while connected with the helicopter.

Do NOT charge on a carpet, cluttered workbench, paper, plastic, vinyl, leather, wood, and the like.

⑥充电时请将电池与充电器放在阴凉处，并远离热源或易燃物品。

Keep it in a cool, dry and ventilated place while charging. Keep it far away from heat and inflammables.

⑦请使用ESKY原厂出品的充电器与电池，禁止使用非原厂产品。

Please use original ESKY charging equipments for charging and flying in case of unexpected damage or injury.

⑧充电过程中，须有人看护，如有异常请及时断开电源，并转移到安全位置。

It needs great care while charging. Never leave it unattended in the process of charging.

Please disconnect the power supply immediately and move to safe place in case you find something abnormal.

However it is normal for the charger and battery to get warm while charging.

六、发射机的介绍 Introduction of Transmitter

1. 发射机各部位介绍 Transmitter Description and Function

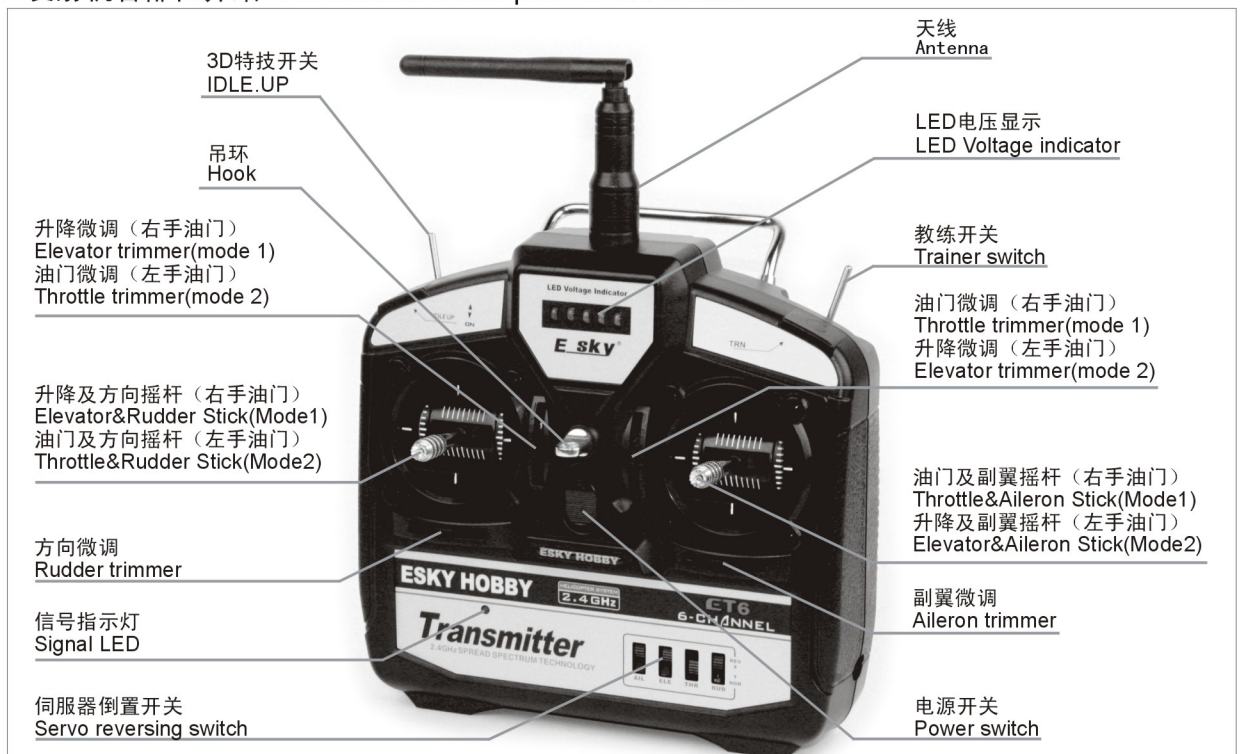

2. 倒置开关 Servo reverse

① 副翼 Aileron

② 升降 Elevator

③ 油门 Throttle

④ 方向舵 Rudder

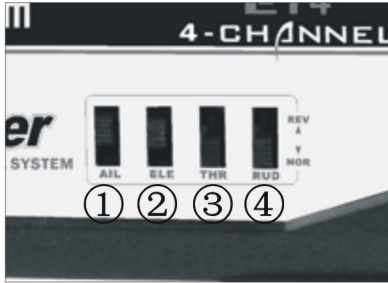

出厂设置

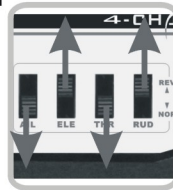

左手油门开关: 下上下上
Mode2:down up down up

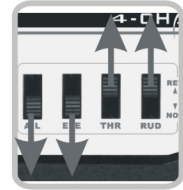

右手油门开关: 下下上上
Mode1:down down up up

倒置开关: 出厂时已按正常使用习惯设置, 如有需要请自行调整。

REVERSE already set to conventional usage pattern at the factory. Adjustable while needed.



LED 指示灯: 指示灯全亮时说明电池电量饱和, 如果只有最后一个红灯闪亮时, 说明电量已经不多, 应及时更换发射机电池。

The battery is full when all the LED lights are on. When the last light turn red and flash, the dry batteries are in low capacity and need to be replaced with new ones.



油门微调: 注意在飞行时或在调整直升机时, 油门摇杆及油门微调一定要打到最低。

The throttle stick and THROTTLE TRIM must be set down to the bottom position while flying or adjusting.



天线: 注意在飞行时要将天线调成如图所示的状态。

Antenna: Please adjust the antenna as it shown in the pictures while flying



电池: 安装电池时须注意电池的正负极性, 切勿装反。

Pay attention to the polarities of the battery. Never install in the reverse direction.

3. 发射机的控制说明 Each control function of transmitter

(右手油门) Mode 1

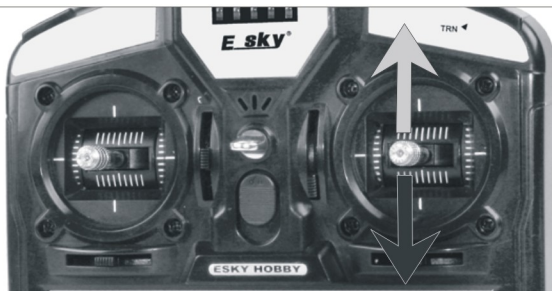

(左手油门) Mode 2



当油门摇杆向上推动时，直升机上升；当油门摇杆向下推动时，直升机下降。
When pushing the THROTTLE stick up or down, the helicopter lifts up or descends accordingly.

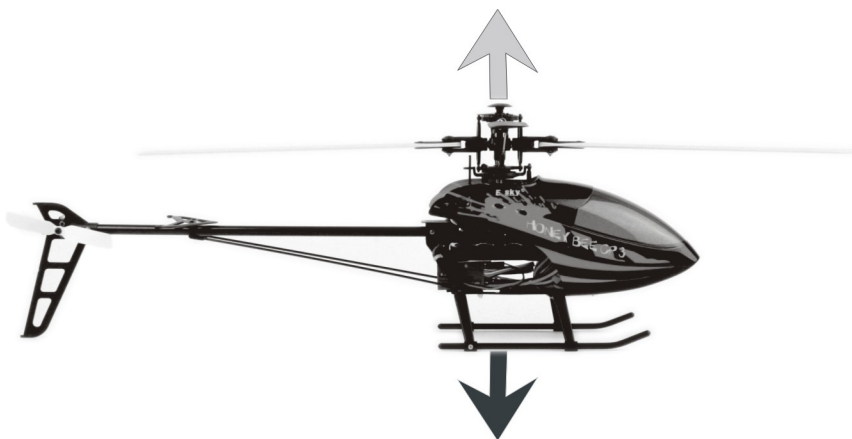

(右手油门) Mode 1

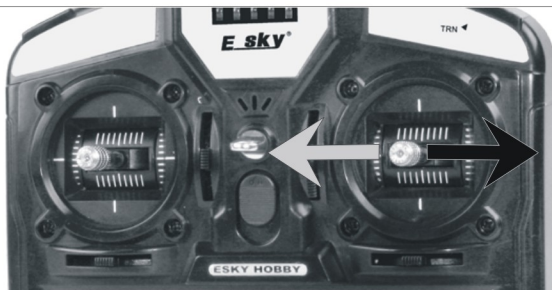

(左手油门) Mode 2

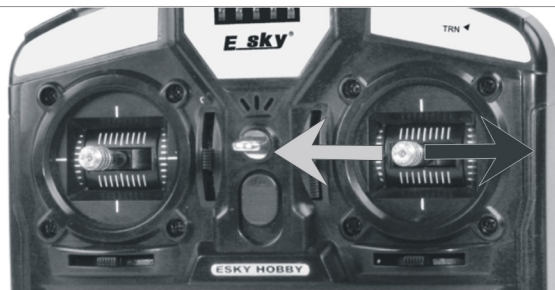

当副翼摇杆向左推动时，直升机飞向左边；当副翼摇杆向右推动时，直升机飞向右边。
When moving the AILERON stick left or right, the helicopter slides left or right accordingly.



(右手油门) Mode 1



(左手油门) Mode 2

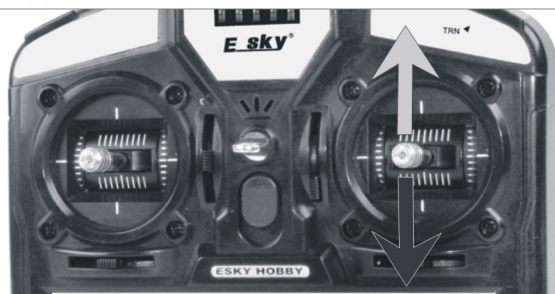

当升降摇杆向上推动时，直升机向前飞行；当升降摇杆向下推动时，直升机向后飞行。
When pushing the ELEVATOR stick up or down, the helicopter moves forward or backward accordingly.



(右手油门) Mode 1



(左手油门) Mode 2

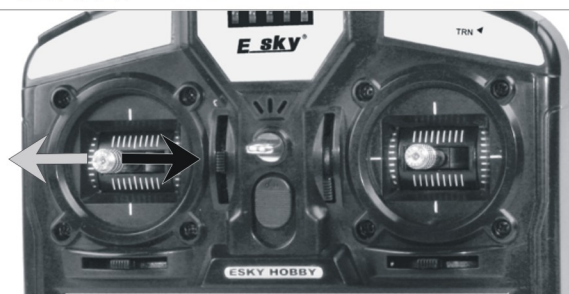

当方向摇杆向左推动时，直升机机头向左转；当方向摇杆向右推动时，直升机机头向右转。
When moving the RUDDER stick left or right, the head of the helicopter moves left or right accordingly.

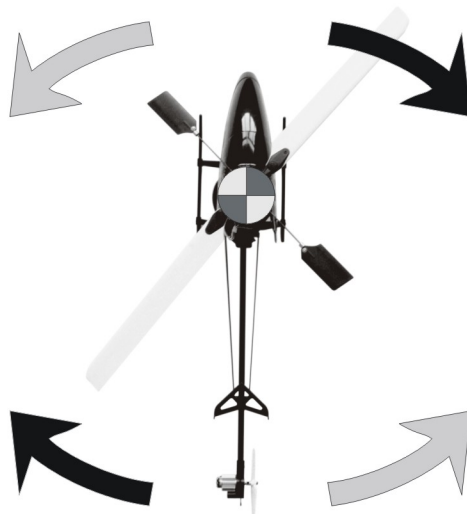

4. 一般模式与特技模式 Normal Flight & Aerobatic Flight

ESKY 6通道直升机用发射机内建特技模式曲线。
按下开关，螺距与油门会自动切换为适合特技飞行的模式。

The ESKY 6channel transmitter included with your honey bee CP3 features a Flight Mode switch. This switch allows the pilot to toggle between the "Normal" and "aerobatic /Idle Up" flight modes during flight.



一般模式 Normal (IDEL UP / OFF)

当发射机上的特技开关处于关闭位置时，油门曲线处于0%至100%的区间。直升机在这种飞行模式下，随着油门曲线从0%的位置往100%变化，螺距曲线从0度到+7度进行变化。这种飞行模式适合基本动作飞行。

When the Flight Mode switch is toggled toward the rear of the transmitter (position 0), the honeybee king3 will be in the Normal (NORM) flight mode. In this flight mode, the throttle curve is linear from 0% to 100%, with a pitch range of approximately 0 degrees (50%) to +7 degrees (100%). This is the preferred flight mode for general hovering and basic (non-aerobatic) flight.

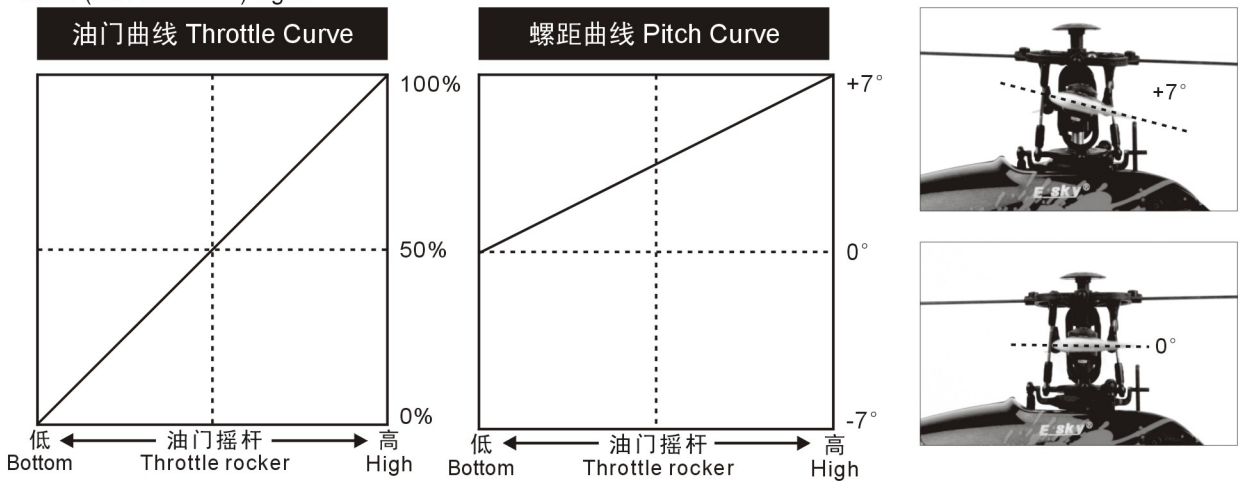

特技模式 Aerobatic (IDEL UP / ON)

当发射机上的特技开关处于打开位置时，直升机处于3D特技飞行模式。在这种飞行模式下，油门曲线从100%位置到100%位置呈现“V”字型状态。随着油门曲线从0%至100%变化，螺距曲线从-7度到+7度进行变化。此时适合进行特技飞行与倒飞动作。

When the Flight Mode switch is toggled toward the front of the transmitter, the 3D helicopter will be in the aerobatic /Idle Up (aerobatic) flight mode. In this flight mode, the throttle curve is "V" shaped from 100% to 100% with 85% throttle at mid-stick, with a pitch range of -7 (0%) to +7 degrees (100%). This is the preferred flight mode for most forward/backward, aerobatic and 3D flying.

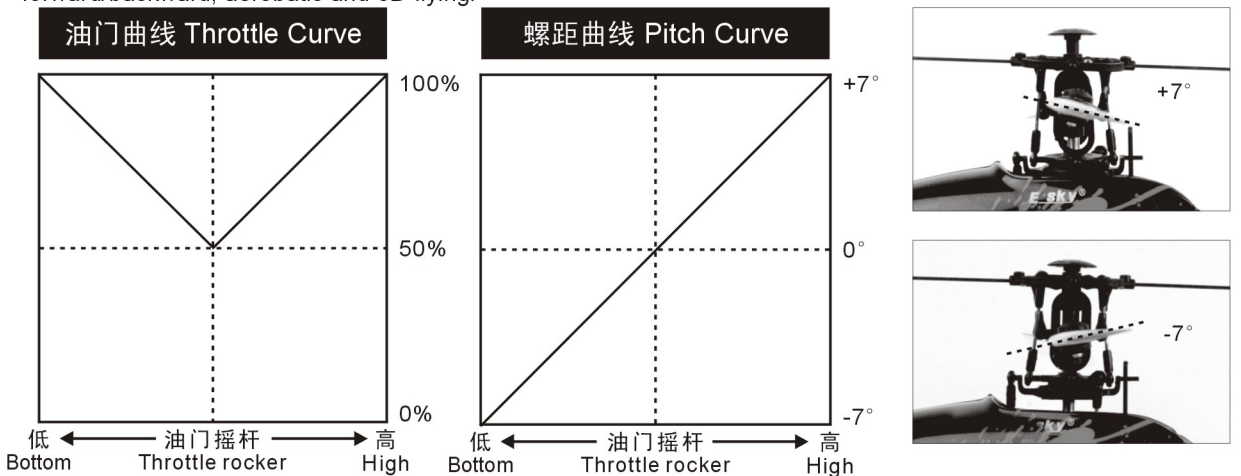

七、飞行前舵面的检查（出厂设置） **Controls Test**

舵面检查：升降舵 Check Elevator

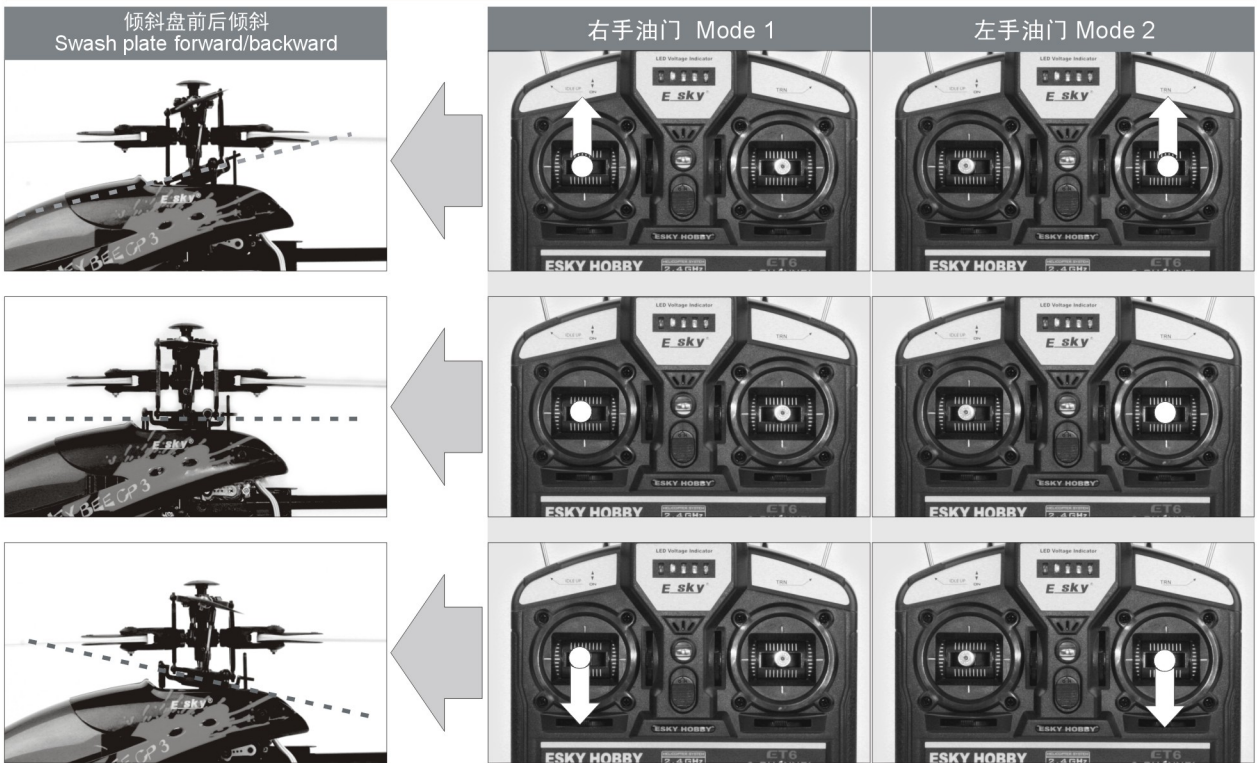

舵面检查：螺距（在特技模式下） Check Pitch(IDEL UP/ON)

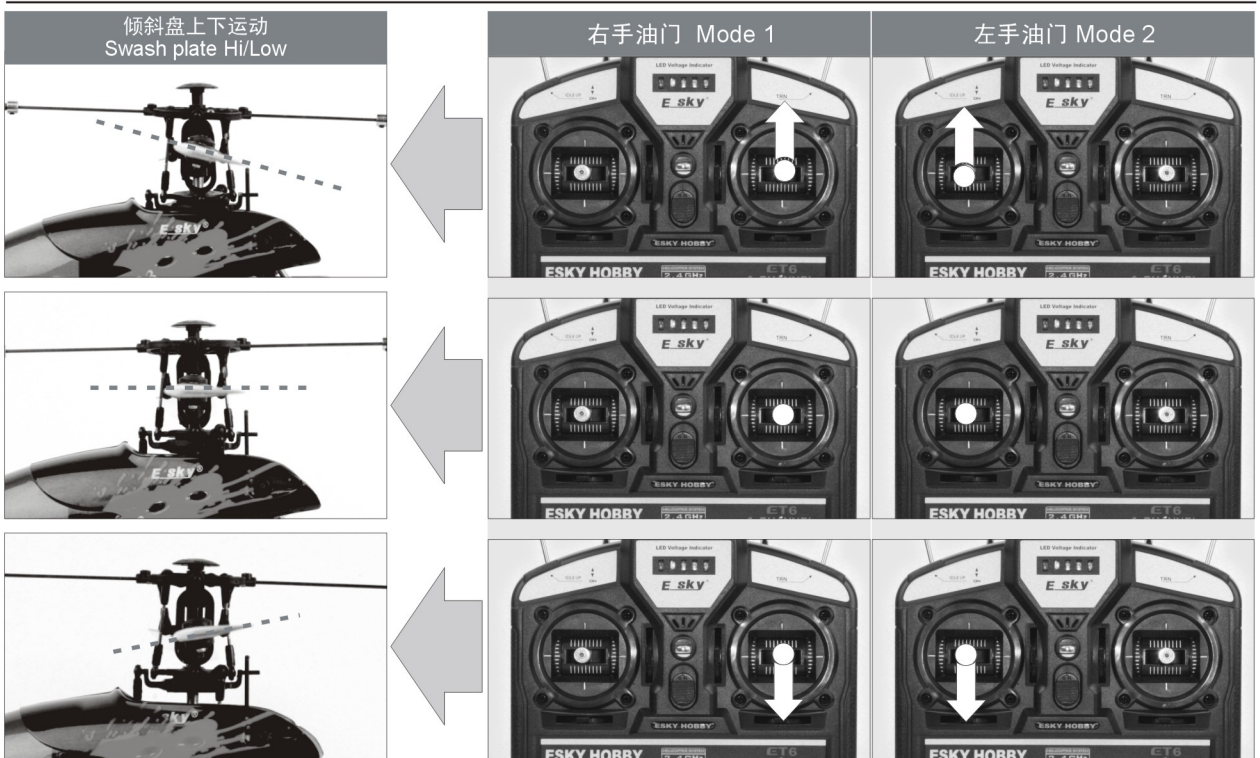

舵面检查：副翼 Check Aileron

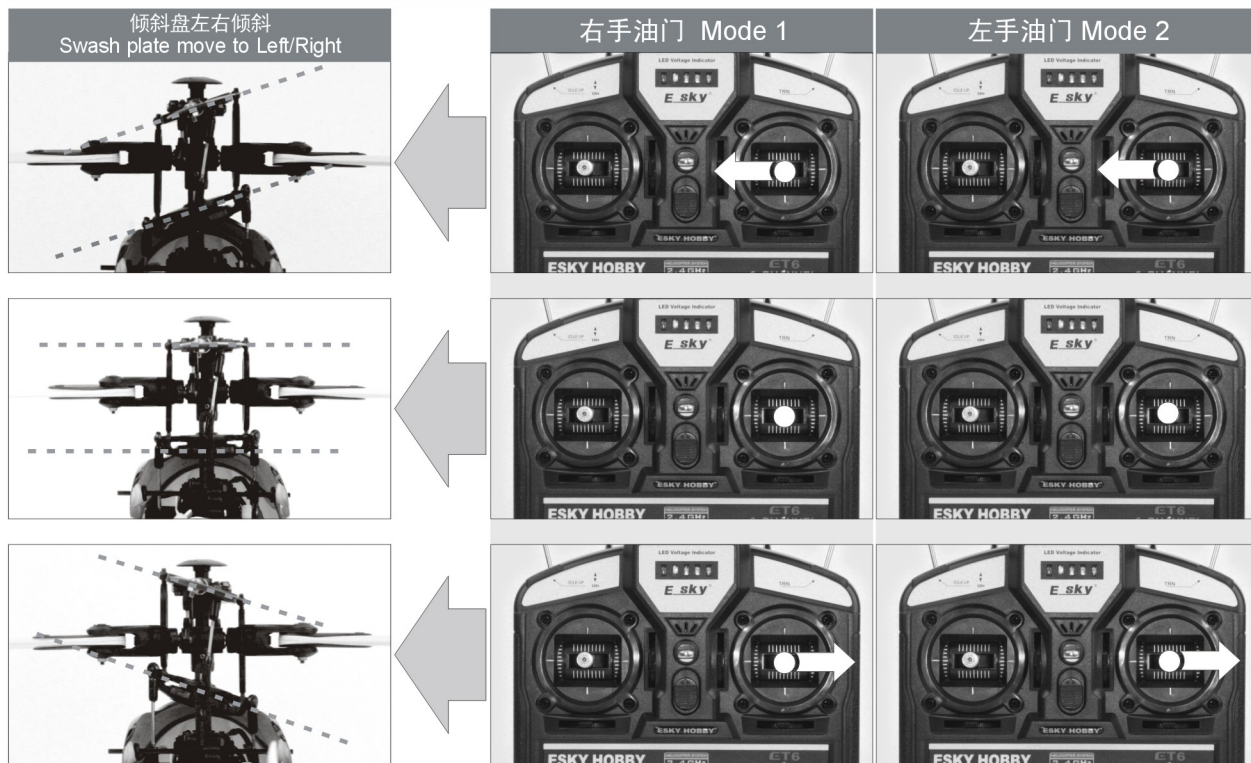

八、直升机部件介绍 Helicopter Parts

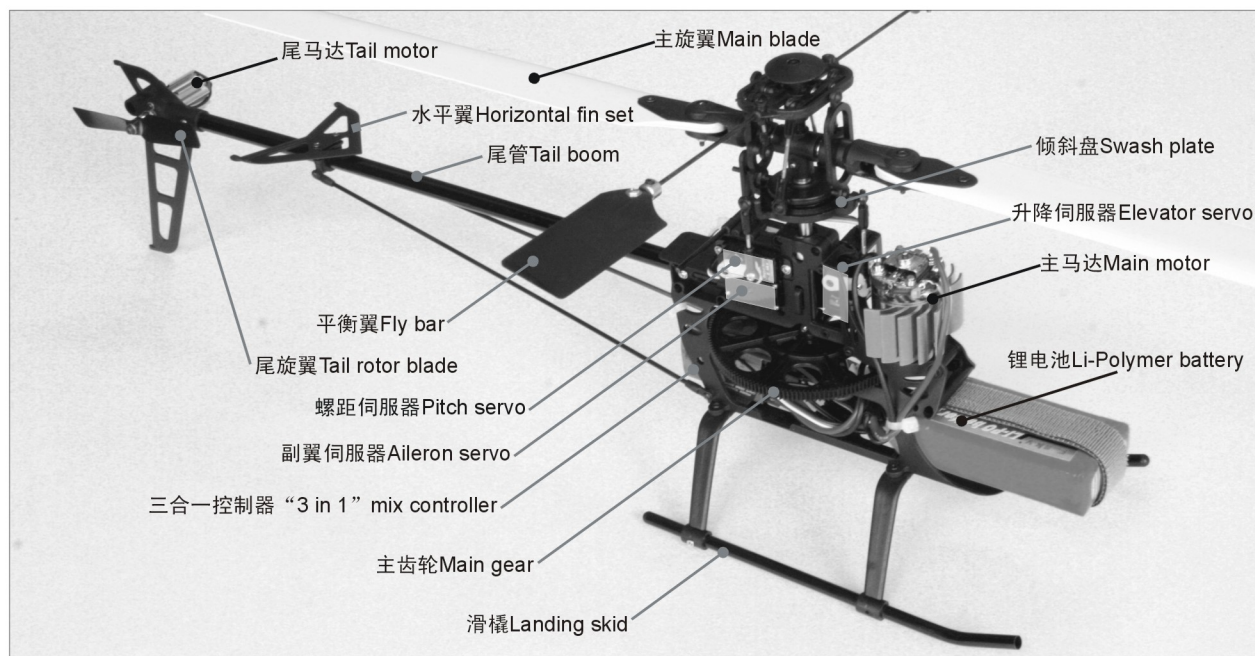

三合一 控制器的连接 Connect to "3 in 1" Mix Controller

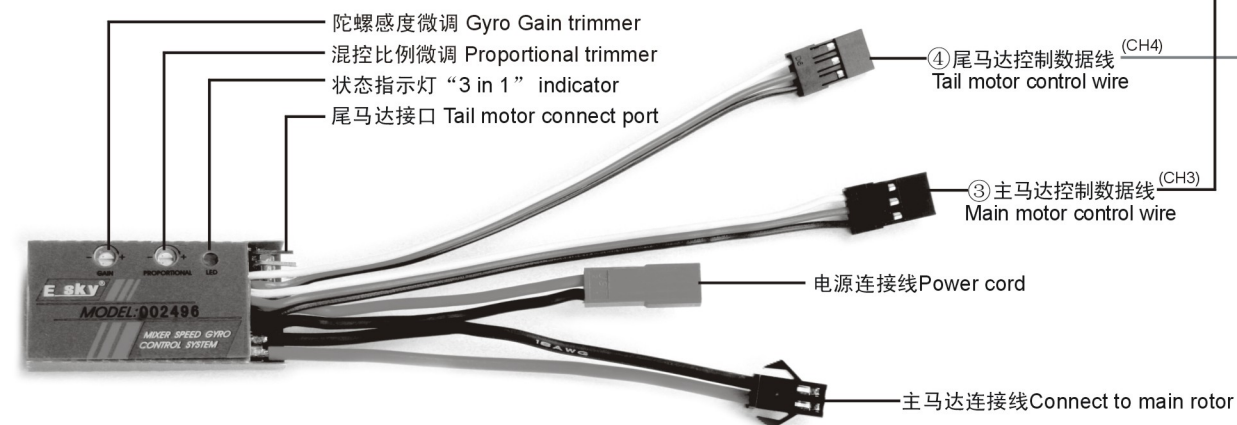
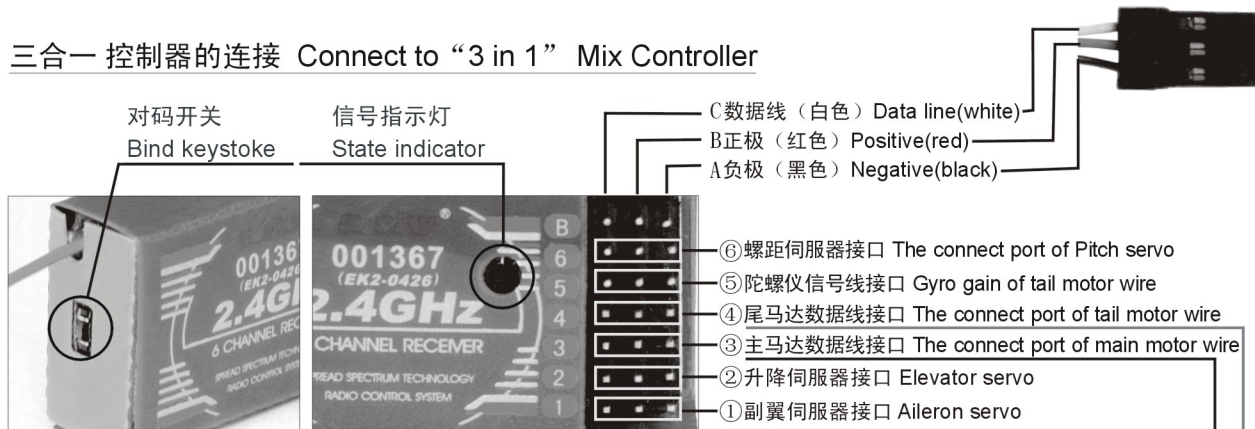

九、重新对码的方法 **How to Re-bind:**

Step 1

按下对码开关 Press the BINDING Button

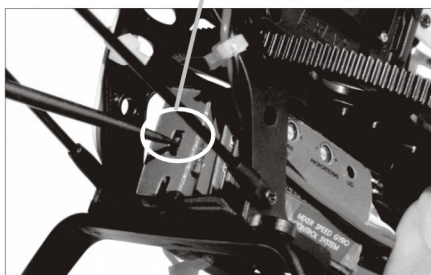

指示灯快速闪烁 LED flashes rapidly

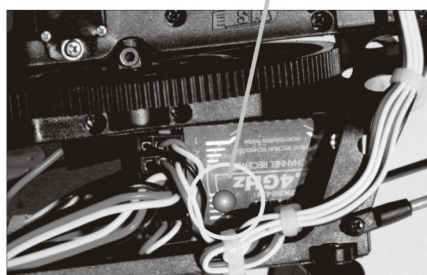

- 1、洗码:先关闭发射机电源,接通直升机电源,再按下对码开关1-2秒,当接收机信号指示灯快速闪烁不止时,表示清除编码已成功:
Unbinding:switch off the TRANSMITTER, power on the helicopter CONTROLLER, and then press the BINDING Button for 1-2 seconds. It indicates unbinding successfully when the LED of receiver flashes rapidly

Step 2

先断开电源Power off the helicopter

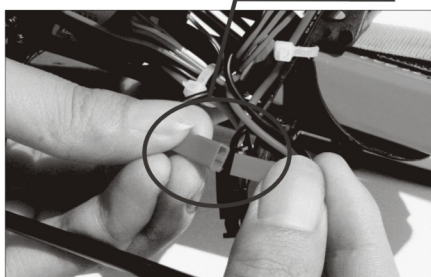

再接通电源Power on the helicopter

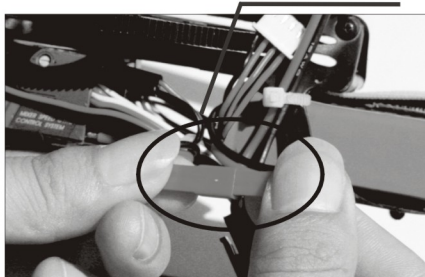

- 2、对码:首先断开直升机电源,然后再接通直升机电源。
Binding:Power off the helicopter at first, then power on the helicopter again.

Step 3

打开发射机电源Turn on the Transmitter

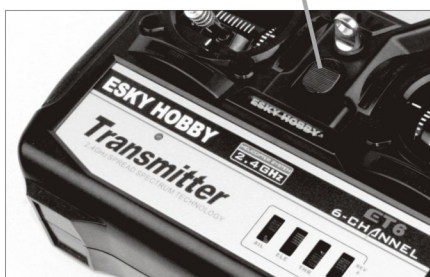

指示灯快速闪烁Signal LED flashes rapidly



- 3、打开发射机电源,发射机信号指示灯快速闪烁,表示正在对码中。
Switch on the TRANSMITTER, If the signal LED on transmitter flashes rapidly it is on binding now.

Step 4

指示灯变为恒亮Signal LED steady light

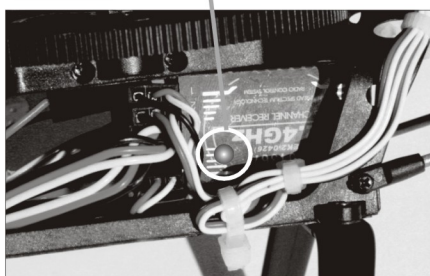

LED灯变为恒亮 LED steady light



- 4、接收机信号指示灯由慢闪变为快闪,然后转为恒亮,成功完成对码。
Receiver signal LED flashes from slowly to rapidly, and then turns steady light, it indicates binding successfully.

(注意:发射机只有在打开发射机电源的前3秒发码,如果3秒后没有成功对码,请重启发射机电源进行对码。)

Note: The TRANSMITTER will send signal code within the first 3 seconds only after it is turned on. If not binding successfully after 3 seconds, please turn on the TRANSMITTER again for re-binding.

十、三合一控制器的调整 3 in 1 Mix Controller Adjustment

1. 混控比例的调节 Proportional Trimmer

在直升机飞行时，如果尾部会往右偏移（机头向左），这时要将混控比例微调往“+”方向（顺时针）调整，调到尾部不再偏移即可。（如图所示）

If the tail rotor blades rotate exceedingly slow, and do not counteract the reactive torque, the tail of the helicopter will move to right side; In that case, please adjust the Proportion Trimmer to increase (+) the r.p.m. of the tail rotor blades.

(Shown as below)

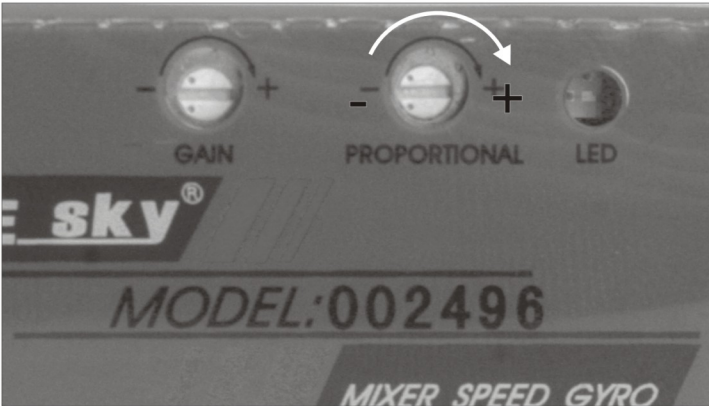

如果尾部往左偏移（机头向右）。这时要将混控微调往“-”方向（逆时针）调整，调到尾部不再偏移即可。（如图所示）

During the flight, the tail rotor blades rotate in a proper proportion to the main rotor blades. If the tail rotor blades rotate exceedingly quick, the tail of the helicopter will move to left side. In that case, please adjust the Proportion Trimmer to decrease (-) the r.p.m. of the tail rotor blades. (Shown as below)

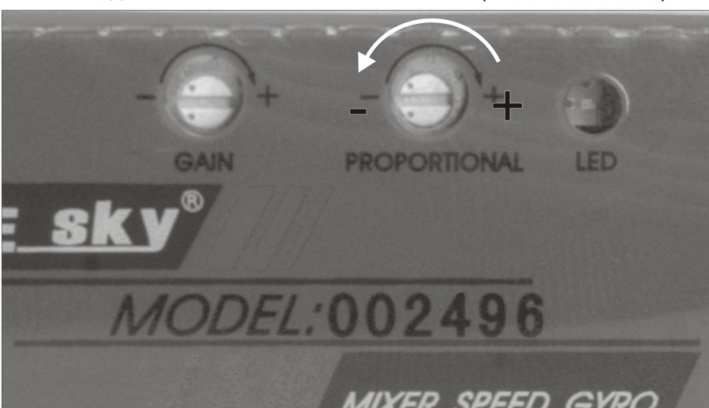

2. 感度调节 Gyro Gain Trimmer

直升机飞行时，如出现尾部不受控制的左右来回小幅抖动，且不受发射机控制，需往“-”方向（逆时针）调整。（如图所示）

During the flight, if the tail is out of control, wobbling slightly from left to right, it indicates that the tail is locked too tight, please adjust the Gain Trimmer to decrease(-) the gyro gain. (Shown as below)



调小陀螺仪感度微调GAIN down (-)



直升机飞行时，如尾部左右来回大幅度摇摆不定，且不受发射机控制，则需往“+”方向（顺时针）调整，调到飞行稳定为止。（如图所示）

If the tail move a large angle to the left or right,wobbling considerably from left to right.Then please adjust the Gain Trimmer to increase(+)the gyro gain. (Shown as below)



调大陀螺仪感度微调GAIN up (+)



十一、主旋翼双桨的调整 Blade tracking adjustment

警告:在观察直升机主旋翼是否有双桨现象时, 必须远离直升机3-5米之间, 以确保安全.

Caution: Be sure to maintain a safe distance from the helicopter (10-15 feet) when tracking the main rotor blades.

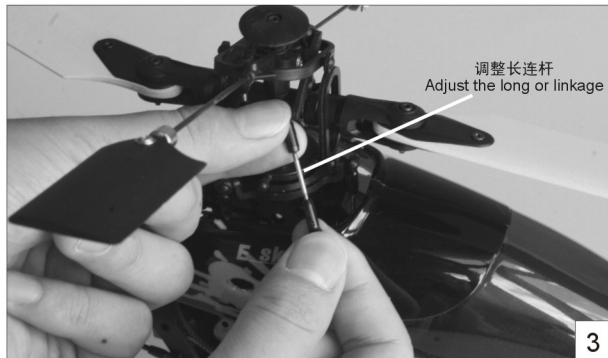
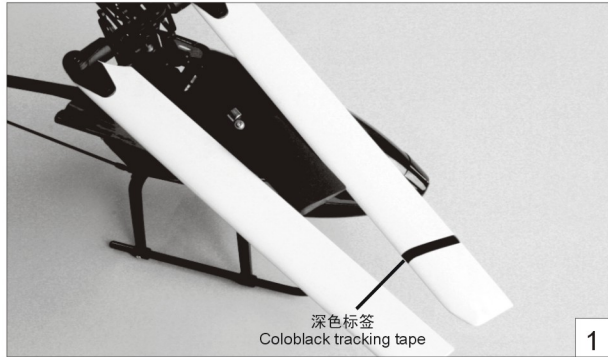

1 主旋翼旋转轨迹直接决定了直升机的飞行性能, 主旋翼不在同一轨迹上旋转, 会使直升机发生震动且难于控制。尽管每台Honey bee cp 3直升机已经在工厂调试完成, 如果主旋翼发生了变动, 还需要进行微小的调试。在其中的一个主旋翼上贴上深色颜色标签, 用来区别主旋翼在旋转中的上下位置。

Blade tracking is a critical element to the flight performance of helicopter, including the honeybee CP3. Main rotor blades that are out of track may cause vibration, instability, and loss of power due to increased drag. Although the main rotor blades of each honeybee CP3 model are tracked at the factory, minor adjustments to blade tracking may be required after blade changes, linkage adjustments or repairs.

The main rotor blades have been brought up to speed, note which blade is running low and which blade is running high (by the colored tracking tape) as shown as above picture.

2 确认好主旋翼的旋转轨迹上下位置后, 关闭直升机的电源, 对主旋翼的连杆进行调整。将主旋翼旋转轨迹在上面的调低, 调短主旋翼与倾斜盘的连杆, 每次将连杆两端的拉杆头旋转一周即可。或者将旋转轨迹在下面的主旋翼调高, 将其与倾斜盘的连杆调长。After confirming which blade is running low and which blade is running high, power down the helicopter to make any necessary adjustments to the linkages. You can increase the pitch of the low blade by shortening the "mixing arm to inner swashplate linkage." This is accomplished by turning one of the Ball Link ends in by one-half to one full turn at a time. Or, you can decrease the pitch of the high blade by lengthening the same linkage.

3 提示: 在调整直升机主旋翼不在同一轨迹旋转时, 需要将其中的一个主旋翼调大距螺或者调小螺距。打开3D特技开关(需要将主尾马达电源线拔掉), 油门摇杆在中间位置时, 两只主旋翼应该处于0度螺距的位置。可以很容易地分辨哪只主旋翼需要调整。如果一只主旋翼螺距低于0度时, 需要调整它与另一只水平。如果一只主旋翼螺距高于0度时, 需要调低它与另一只水平。

Note: The blade you choose to raise or lower when making tracking adjustments will depend on the pitch of each blade. Because both rotor blades should be as close to 0 degrees as possible when Throttle Hold is activated (DO NOT attempt to check for 0 pitch in the Normal or Stunt/IdleUp flight modes) and the throttle/collective stick is in the middle position, you can easily identify which rotor blade to adjust. If one blade is "lower" than 0 degrees, raise it to match the other blade. If one blade is "higher" than 0 degrees, lower it to match the other blade.

4 不需要太多的调整两只主旋翼就会在同一轨迹上。如果经过了必要的调整, 并且主旋翼与倾斜盘上的两支连杆一样长, 还是有双桨现象, 那么需要检测主旋翼有没有变形或破损。严格的说同一台直升机上两只主旋翼必须是完全一样的。如果经过调整连杆长短后, 两只主旋翼还是不能达到重合状态, 不要担心, 只要两只主旋翼接近于同一轨迹也会飞行的很好。

Typically, not much adjustment should be necessary to properly track the main rotor blades. If significant adjustments are required, be sure to double-check the length of both mixing arm to inner swashplate linkages (they should be close to the same length). You should also check the blades for any warps or twists. In most cases, you should be able to get both blades tracking perfectly in the same plane. However, due to slight variations in the ball links and threaded linkage rods/pushrods it may not always be possible to achieve absolutely perfect blade tracking. Don't worry, as the helicopter should still perform well as long as the blade tracking is adjusted as closely as possible.

十二、飞行操作步骤 Procedure for flight

1. 起飞步骤 The process step of flight



将充满电的电池放入电池槽，用绑带将电池固定好，并确定不会松动。

Place the fully-charged BATTERY PACK into the slot, and fix with the band.

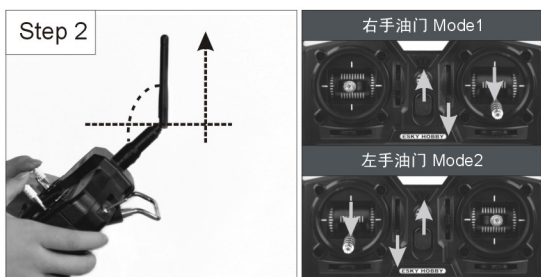

在飞行时要将天线调成如图所示的状态，油门摇杆与油门微调移至最下方，其它微调置中，开启发射机电源。

Please adjust the antenna as it shown in the pictures while flying;

Set both the TROTTLE STICK and TROTTLE TRIM down to bottom, while others centered. And then turn on the TRANSMITTER.

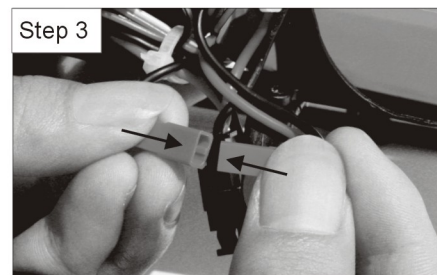

接通直升机电源。

Connect the BATTERY PACK to the helicopter.

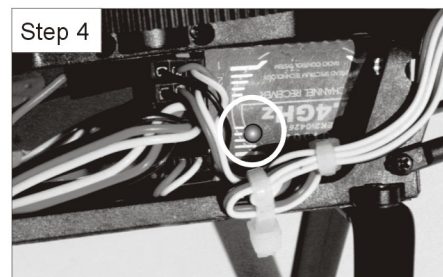

绿灯恒亮即显示进入待飞状态。

It is ready to fly when the green light on "3 in 1" controller turns on.

2. 结束飞行的步骤 The process step of landing and off flight.

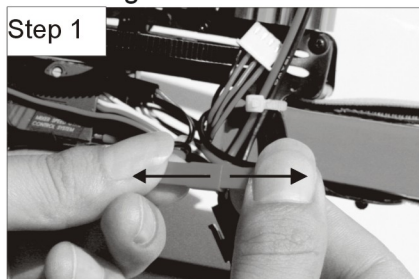

一定要先断开直升机电源；

Always disconnect the BATTERY PACK from the helicopter before turn off the TRANSMITTER.

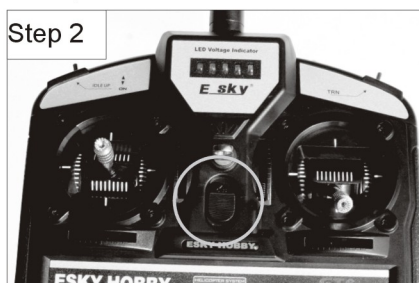

然后再关闭发射机电源；

Power off the transmitter;

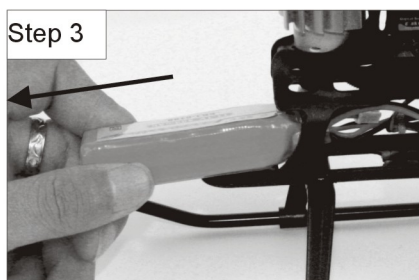

取出直升机的电池与发射机内的电池，并请妥善保存。

Remove both the BATTERY PACK of the helicopter and the DRY BATTERIES of the transmitter and keep it well.

十三、分解图 Exploded view

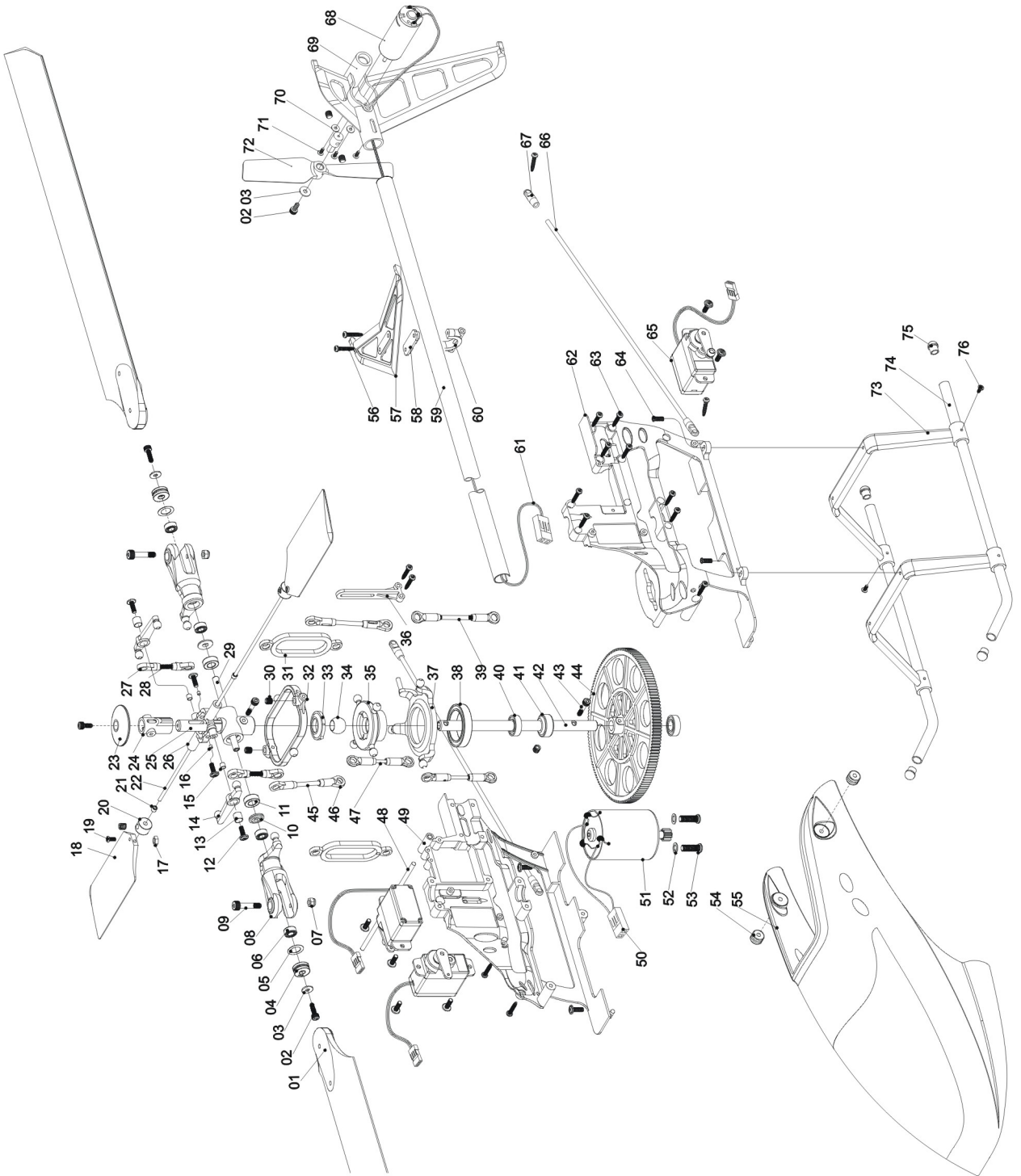

NO.	名称 Description	用量 Qty need	规格 Specification	NO.	名称 Description	用量 Qty need	规格 Specification
1	主旋翼 Main blade	2		40	滚珠轴承 Ball bearing	2	MR105zz
2	棋子头螺丝 Screw sets	4	M2*5	41	主轴固定环 Main shaft fixed collar	1	Φ5*Φ10*6
3	垫片 Spacer	2	Φ2*Φ5.6*0.5	42	主轴 Main shaft	1	Φ3*Φ5*85
4	止推轴承 Thrust bearing	2	Φ3*Φ8*3.5	43	棋子头螺丝 Screw sets	2	M2*10*6
5	垫片 Spacer	2	Φ5*Φ8*0.1	44	主齿轮 Main gear	1	
6	滚珠轴承 Ball bearing	4	MR63zz	45	无头螺纹拉杆 Thread brace rod	2	Φ1.4*28
7	防松螺母 Locknut	2	M2 1018	46	长单孔拉杆头 Long-single push rod	10	
8	主旋翼夹头 Main blade clamp	2		47	拉杆 Push rod	2	Φ1.4*20
9	棋子头螺丝 Screw sets	2	M2*14	48	碳纤维杆 Carbon rod	1	Φ2*70
10	台阶垫片 Step spacer	2	Φ3*Φ7.5*1.2	49	右机架 Right framework	1	
11	O 形圈 O ring	2	Φ3*Φ7*3	50	主马达线 Main motor wire	1	
12	伞头十字螺丝 Screw sets	11	ST1.7*4	51	主马达组 Main motor set	1	
13	铜套 Copper sheath	2	Φ3.5*Φ4*3.5	52	垫片 Spacer	2	Φ31*Φ8*10
14	SF 控制臂 SF control arm	2		53	圆头螺丝 Round head screw set	2	M3.0*6
15	铜套 Copper sheath	2	Φ3*Φ3.5*3.6	54	软胶头 Plastic pad	2	
16	铜套 Copper sheath	2	Φ18*Φ25*16	55	机壳 Cabin	1	
17	螺母 Nut	2	M2	56	P 头十字螺丝 Philips head screw	4	ST1.7*9
18	平衡翼 Paddle	2		57	水平翼 Horizontal fin set	1	
19	伞头十字螺丝 Philips head screw	2	M2*6	58	水平翼垫块 Padding block of Horizontal fin	1	
20	平衡翼配重块 Paddle balance weight	2		59	尾管 Tail boom	1	Φ7*Φ8*290
21	铜套 Copper sheath	2	Φ1.5*Φ2.5*2	60	水平翼固定座 Horizontal fin mounting set	1	
22	平衡翼杆 Flybar	1	Φ1.5*200	61	尾马达线 Tail Motor wire	1	
23	刹车碟 Disc Brakes	1		62	左机架 Left framework	1	
24	相位滑套 Aspect sliding sleeve	1		63	P 头十字螺丝 Philips head screw	12	ST1.7*6
25	主旋翼头 Main rotor head	1		64	十字槽盘头螺丝 Cruciform slotted Screw	4	1.7*6
26	平衡杆固定座 Balancing pole mounting	1		65	舵机 Servo	3	
27	短单孔拉杆头 Single push rod	4		66	碳纤维杆 Carbon rod	2	
28	全牙连杆 B Linking rod B	2	M1.7*10	67	支撑杆头 Strut bar	4	
29	横轴 Horizontal axis	1	Φ3*47.8	68	尾马达 Tail Motor	1	
30	基米螺丝 Kimi screw	7	M3*3	69	尾架 Tail Frame	1	
31	双孔拉杆 Ring-link push-rod	2		70	垫片 Spacer	2	Φ2*Φ4*03
32	平衡翼控制臂 Paddle control arm	1		71	平头十字螺丝 Philips head screw	2	M1.6*3
33	倾斜内盘球头盖 Ball cover	1		72	尾旋翼 Tail rotor blade	1	
34	倾斜球 Ball of inner swashplate	1	Φ5*SΦ8.0*6	73	滑橇支架 Skid bar	2	
35	倾斜内盘 Inner swashplate	1		74	滑橇 Skid	2	
36	十字盘导板 Anti-washout set	1		75	滑橇管塞 Tube stopper of skid	4	
37	倾斜外盘 Out swashplate	1		76	平头十字螺丝 Philips head screw	2	TPF1.7*4
38	滚珠轴承 Ball bearing	1	6702ZZ				
39	无头螺纹拉杆 Thread brace rod	1	Φ1.4*32				

十四、整机配件图 Spare parts picture

000152



Charger for 2- 3cell Li-Poly
平衡充电器

002497



11.1v, 1000mAh

Li-Polymer battery
锂电池

000511



Switching adapter(U.K)
适配器 (英规)

000512



Switching adapter(Europe)
适配器 (欧规)

000513



Switching adapter(USA)
适配器 (美规/日规)

000538



Switching adapter(Australia)
适配器 (澳规)

000204



Allen Key & fastener
工具组

000196



$\phi 3 \times \phi 6 \times 2.5$

Bearing set
滚珠轴承组

000257



$\phi 5 \times \phi 10 \times 3$

Bearing set
滚珠轴承组

002381

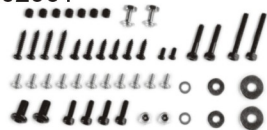

Screw set
螺丝组

001065



M2*6(10pcs)

Cap Screw set
棋子头螺丝组

000232



Paddle balance weight
平衡翼配重块

000215

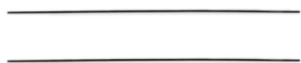

Flybar
平衡翼杆

000217



Paddle
平衡翼

000710



Skid bar set
滑撬支架组

002385



Skid set(black)
滑撬组 (黑色)

002365



Swashplate guide plate
十字盘导板

002363



Frame kit
机架

002369



Horizontal fin set
水平翼套件

002374

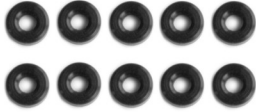

O ring(black)
O形圈 (黑色)

002377



$\Phi 5^* \Phi 8^* 0.1$

Spacer
垫片

002366



Main shaft fixed collar
主轴固定环

002367



Tail boom
尾管

002382

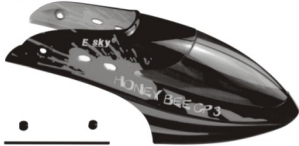

Canopy set(black)
机壳组 (黑色)

002371



Tail Frame
尾架

002375

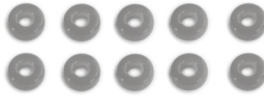

O ring(red)
O形圈 (红色)

002378



$\Phi 3^* \Phi 8^* 3.5$

Thrust bearing
止推轴承

002418



$\Phi 3^* \Phi 7.5^* 1.1$

Step spacer
台阶垫片

002380



Horizontal axis
横轴

002383



Canopy set(white)
机壳组 (白色)

002386



Tail blade set
尾旋翼组

002376



O ring(Blue)
O形圈 (蓝色)

002379

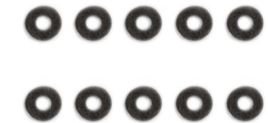

$\Phi 2^* \Phi 5.6^* 0.5$

Spacer
垫片

002384

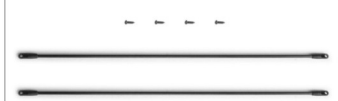

Knighthead Set
支撑杆

002373



Main shaft
主轴

002368

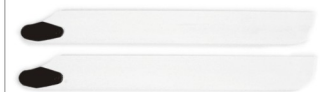

Main blade
主旋翼

002393



370 Super motor
370强磁马达

002445



Tail motor
尾马达

002387



Motor wires
马达线

002446



Main motor heat-sink
主马达散热罩

002447



Tail motor heat-sink
尾马达散热罩

002412



SF control arm
SF控制臂

002413

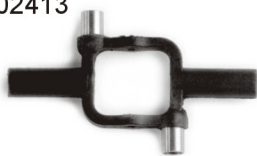

Balancing bar mounting set
平衡杆固定座

002364

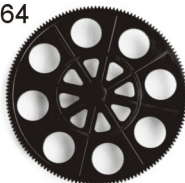

Main gear
主齿轮

002415



Swashplate set
倾斜盘组

002416

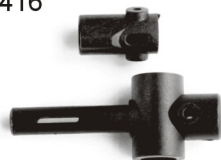

Center hub set
主旋转头套件

002417



Main blade clamp set
主旋翼夹头组

002411

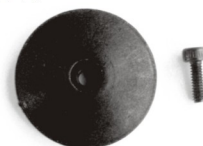

Disc brakes
刹车碟

002419



Ring-like push-rod
双孔拉杆

002420



1.6*32, 1.6*24, 1.6*20

Push rod set
拉杆组

002421



1.6*28

Push rod set
拉杆组

002422



1.7*10

Push rod set
拉杆组

002414



Paddle control arm
平衡翼控制臂

000155



Digital servos 7.5g
7.5g数字伺服器

000589

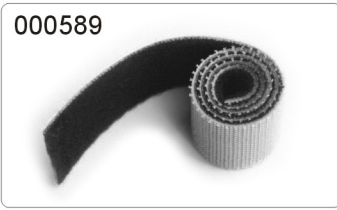

Battery band
电池绑带

001367



2.4GHz, 6CH receiver
2.4GHz 6通道接收机

002496

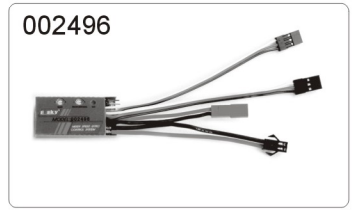

"3 in 1" mix controller
三合一控制器



2.4GHz, 6CH transmitter
2.4GHz 6通道发射机

TEL: 86-0755-81728002
86-0755-81728009

E-mail: esky@esky-sz.cn

Zip code: 518103

28 Building North Yongfa Industrial Park, JinXiu Road, Heyi Village,
Shajing Town, Bao An district, ShenZhen, China

电 话: 86-0755-81728002
86-0755-81728009

电子邮箱: esky@esky-sz.cn

邮政编码: 518103

深圳市宝安区沙井镇和一村锦绣路北方永发科技园28栋